



# Precision Mass Flow Controller Operating Manual

Notice: The manufacturer reserves the right to make any changes and improvements to the products described in this manual at any time and without notice. This manual is copyrighted. This document may not, in whole or in part, be copied, reproduced, translated, or converted to any electronic medium or machine readable form, for commercial purposes, without prior written consent from the copyright holder.

Note: Although we provide assistance on our products both personally and through our literature, it is the complete responsibility of the user to determine the suitability of any product to their application.

The manufacturer does not warrant or assume responsibility for the use of its products in life support applications or systems.

## **Warranty**

This product is warranted to the original purchaser for a period of one year from the date of purchase to be free of defects in material or workmanship. Under this warranty the product will be repaired or replaced at manufacturer's option, without charge for parts or labor when the product is carried or shipped prepaid to the factory together with proof of purchase. This warranty does not apply to cosmetic items, nor to products that are damaged, defaced or otherwise misused or subjected to abnormal use. See "Application" under the Installation section. Where consistent with state law, the manufacturer shall not be liable for consequential economic, property, or personal injury damages. The manufacturer does not warrant or assume responsibility for the use of its products in life support applications or systems.

### **Conformity / Supplemental Information:**

The product complies with the requirements of the Low Voltage Directive 2006/95/EC and the EMC Directive 2004/108/EC and carries the CE Marking accordingly. Contact the manufacturer for more information.

## **Thank you for purchasing an MC-Series Gas Flow Controller.**

Please take the time to read the information contained in this manual. This will help to ensure that you get the best possible service from your instrument. This manual covers the following MC-Series instruments:

### **MC-Series Mass Gas Flow Controllers**

### **MCR-Series Mass Gas Flow Controllers**

### **MCW-Series Low Pressure Drop Mass Flow Controllers**

### **MCS-Series Mass Gas Flow Controllers**

### **MCRS-Series Mass Gas Flow Controllers**

MCS and MCRS-Series Flow Controllers are for use with certain aggressive gases (see page 78)

This includes MC and MCR-Series devices labeled as approved for CSA Class 1 Div 2 and ATEX Class 1 Zone 2 hazardous environments. See pages 99 and 100 for Special Conditions regarding the use of CSA/ATEX labeled devices.

### **MCV-Series Mass Gas Flow Controllers**

MCV-Series Flow Controllers have an integrated shut-off valve and are built for use with applications that require tight shut-off (see pages 30 and 71).

### **MCP-Series Mass Gas Flow Controllers**

MCP-Series Flow Controllers are built with a high performance control valve for use with certain lower pressure applications (see page 73)

### **MCD-Series Dual Valve Mass Gas Flow Controllers** (see pages 31 and 82)

Unless otherwise noted, the instructions in this manual are applicable to all of the above instruments.

Full specifications for each device can be found on pages 61 through 82.



***Please contact Your dealer if you have any questions regarding the use or operation of this device.***

***Many MC-Series instruments are built for specific applications. Two instruments with the same flow range and part number may look and act quite differently depending upon the application the instrument was built for. Care should be taken when moving an instrument from one application to another.***

| <b>TABLE OF CONTENTS</b>                        | <b>Page</b> |
|---|-------------|
| GETTING STARTED                                 | 6           |
| MOUNTING  | 6           |
| PLUMBING  | 7           |
| POWER AND SIGNAL CONNECTIONS                    | 8           |
| INPUT SIGNALS                                   | 9           |
| Analog Input Signal                             | 9           |
| RS-232 / RS-485 Digital Input Signal            | 10          |
| OUTPUT SIGNALS                                  | 11          |
| RS-232 / RS-485 Digital Output Signal           | 11          |
| Standard Voltage (0-5 Vdc) Output Signal        | 11          |
| Optional 0-10 Vdc Output Signal                 | 11          |
| Optional Current (4-20 mA) Output Signal        | 11          |
| Optional 2nd Analog Output Signal               | 11          |
| Information for TFT (Color Display) Instruments | 13          |
| DISPLAYS AND MENUS                              | 14          |
| MAIN  | 15          |
| Gas Absolute Pressure                           | 15          |
| Gas Temperature                                 | 15          |
| Set-Pt.   | 15          |
| Volumetric Flow Rate                            | 15          |
| Mass Flow Rate                                  | 16          |
| <i>Flashing Error Message</i>                   | 16          |
| SELECT MENU                                     | 17          |
| CONTROL SETUP                                   | 18          |
| Set-Point Source                                | 18          |
| Loop Variable                                   | 19          |
| On / Off Auto-tare                              | 19          |
| PID Tuning                                      | 20          |
| GAS SELECT                                      | 22          |
| Composer  | 23          |
| COMMUNICATION SELECT                            | 25          |
| Unit ID   | 25          |
| Baud  | 25          |
| MISCELLANEOUS                                   | 26          |
| MISC1   | 26          |
| Zero Band                                       | 26          |
| Pressure Averaging                              | 26          |
| Flow Averaging                                  | 26          |
| LCD Contrast                                    | 26          |
| MISC2   | 27          |
| Standard Temperature and Pressure               | 27          |
| DIAG TEST                                       | 28          |
| Rotate Display                                  | 28          |
| DEVICE UNITS                                    | 28          |
| MANUFACTURER DATA                               | 29          |

| <b>TABLE OF CONTENTS</b>                                    | <b>Page</b> |
|---|-------------|
| MCV Controller Operating Notes                              | 30          |
| MCD Controller Operating Notes                              | 31          |
| RS-232 or RS-485 Output and Input                           | 33          |
| Configuring HyperTerminal®                                  | 33          |
| Streaming Mode  | 33          |
| Changing from Streaming to Polling Mode                     | 33          |
| Sending a Set-Point via RS-232 or RS-485                    | 34          |
| To adjust the P & D terms via RS-232 or RS-485              | 35          |
| Gas Select  | 36          |
| Creating and Deleting Gas Mixtures using RS-232 or RS-485   | 37          |
| Collecting Data   | 38          |
| Data Format   | 38          |
| Sending a Simple Script File to HyperTerminal®              | 39          |
| Operating Principle   | 40          |
| Standard Gas Data Tables                                    | 40          |
| Gas Lists with Viscosities, Densities and Compressibilities | 41          |
| Supported Units List  | 49          |
| Troubleshooting   | 51          |
| Maintenance and Recalibration                               | 53          |
| Option: Totalizing Mode                                     | 54          |
| Option: Remote Electronics                                  | 56          |
| Option: Remote Panel Display                                | 56          |
| Accessory: Multi-Drop Box                                   | 57          |
| Accessory: Flow Vision™ SC                                  | 58          |
| Accessory: Flow Vision™ MX                                  | 58          |
| Accessories   | 59          |
| MC and MCR Technical Specifications                         | 61          |
| MCW Technical Specifications                                | 67          |
| MCV & MCVS Technical Specifications                         | 71          |
| MCP Technical Specifications                                | 73          |
| MCD and MCRD Technical Specifications                       | 76          |
| MCS and MCRS Technical Specifications                       | 78          |
| PROFIBUS Technical Specifications and Pin-outs              | 83          |
| <b>Eight Pin Mini-DIN Pin-Out</b>                           | 84          |
| <b>Locking Industrial Connector Pin-Out</b>                 | 85          |
| <b>DB9 Pin-Out Diagrams</b>                                 | 86          |
| <b>DB15 Pin-Out Diagrams</b>                                | 92          |
| <b>Information for CSA and ATEX Labeled Devices</b>         | 99          |

## GETTING STARTED

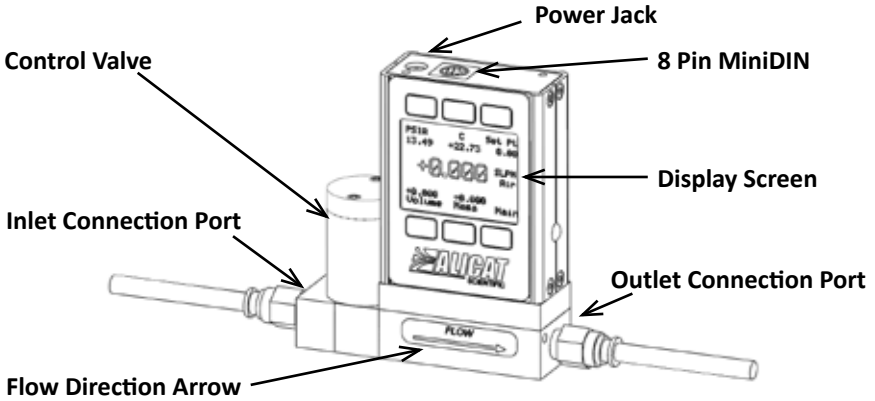

Small Valve Mass Flow Controller shown with an upstream valve configuration and connection port fittings

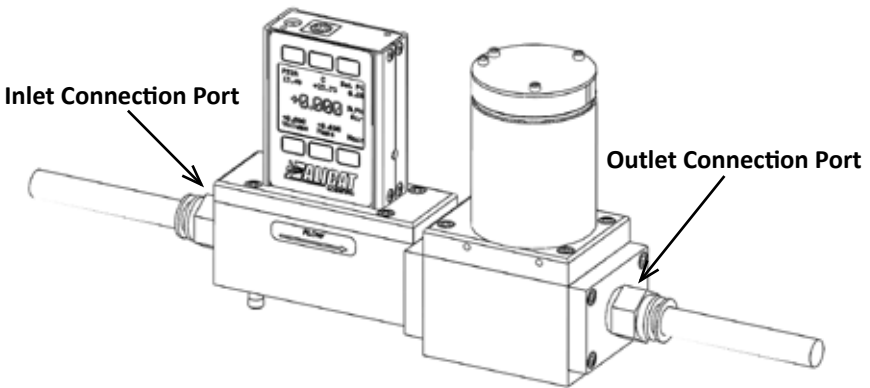

Large Valve Mass Flow Controller shown with a downstream valve configuration and connection port fittings

## MOUNTING

MC-Series Gas Flow Controllers have holes on the bottom for mounting to flat panels. See pages 61- 82.

Small valve controllers (MC-Series) can usually be mounted in any position.

**Large valve controllers (MCR-Series) should be mounted so that the valve cylinder is vertical and upright.** Mounting a large valve controller in another position increases the risk of leakage when the controller is being held closed by the spring force.

No straight runs of pipe are required upstream or downstream of the controller.

## PLUMBING



**Your controller is shipped with plastic plugs fitted in the port openings. To lessen the chance of contaminating the flow stream do not remove these plugs until you are ready to install the device.**

**Make sure that the gas will flow in the direction indicated by the flow arrow.**

Standard MC-Series Gas Flow Controllers have female inlet and outlet port connections. Welded VCR and other specialty fittings may have male ports.

The inlet and outlet port sizes (process connections) for different flow ranges are shown on pages 61 - 82.

Controllers with M5 (10-32) ports have O-ring face seals and require no sealant or tape. Do not use tape with welded or o-ring fittings.

For non M5 (10-32) ports use thread sealing Teflon® tape to prevent leakage around the port threads.

**Do not wrap** the first two threads. This will minimize the possibility of getting tape into the flow stream and flow body.



**Do not use pipe dopes or sealants on the process connections as these compounds can cause permanent damage to the controller should they get into the flow stream.**

When changing fittings, carefully clean any tape or debris from the port threads.

**We recommend the use of in-line sintered filters to prevent large particulates from entering the measurement head of the instrument. Suggested maximum particulate sizes are as follows:**

**5 microns for units with FS flow ranges of 0-1 sccm or less.**

**20 microns for units with FS flow ranges between 0-2 sccm and 0-1 slpm.**

**50 microns for units with FS flow ranges of 0-1 slpm or more.**

## PRESSURE

Maximum operating line pressure is 145 psig (1 MPa).

If the line pressure is higher than 145 psig (1 MPa), use a pressure regulator upstream from the flow controller to reduce the pressure to 145 psig (1 MPa) or less.

MCP mass flow controllers are fitted with a high performance valve for low pressure applications.



**MCP mass flow controllers have a maximum operating line pressure of 80 psig. See page 73.**



**CAUTION! EXCEEDING THE MAXIMUM SPECIFIED LINE PRESSURE MAY CAUSE PERMANENT DAMAGE TO THE SOLID-STATE DIFFERENTIAL PRESSURE TRANSDUCER.**

## POWER AND SIGNAL CONNECTIONS

Power can be supplied to your controller through either the power jack (power jack not available on CSA/ATEX approved devices) or the 8 pin Mini-DIN connector.

An AC to DC adapter which converts line AC power to DC voltage and current as specified below is required to use the power jack.

**Small Valve** controllers require a 12-30Vdc power supply with a 2.1 mm female positive center plug capable of supplying 250 mA. **NOTE:** 4-20mA analog output requires at least 15 Vdc.

**Large Valve** controllers require a 24-30 Vdc power supply with a 2.1 mm female positive center plug capable of supplying at least 750mA.

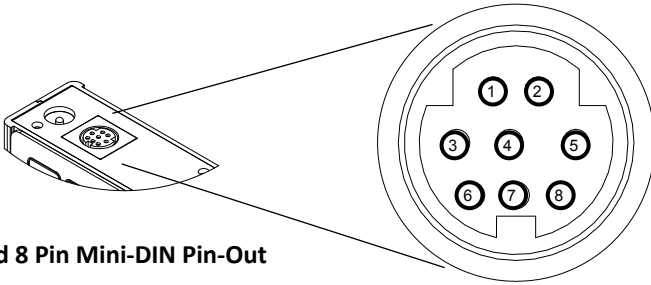

**Standard 8 Pin Mini-DIN Pin-Out**

| Pin | Function   | Mini-DIN cable color |
|-----|--|----------------------|
| 1   | Not Connected (or optional 4-20mA Primary Output Signal)                                   | Black                |
| 2   | Static 5.12 Vdc [or optional Secondary Analog Output (4-20mA, 5Vdc, 10Vdc) or Basic Alarm] | Brown                |
| 3   | Serial RS-232RX / RS-485(-) Input Signal (receive)   | Red                  |
| 4   | Meters/Gauges = Remote Tare (Ground to Tare)<br>Controllers = Analog Set-Point Input       | Orange               |
| 5   | Serial RS-232TX / RS-485(+) Output Signal (send)   | Yellow               |
| 6   | 0-5 Vdc (or optional 0-10 Vdc) Output Signal   | Green                |
| 7   | Power In (as described above)  | Blue                 |
| 8   | Ground (common for power, communications and analog signals)                               | Purple               |

**Note:** The above pin-out is applicable to all the flow meters and controllers with the Mini-DIN connector. The availability of different output signals depends on the options ordered. Optional configurations are noted on the unit's calibration sheet.



**CAUTION! DO NOT CONNECT POWER TO PINS 1 THROUGH 6 AS PERMANENT DAMAGE CAN OCCUR!**



**It is common to mistake Pin 2 (labeled 5.12 Vdc Output) as the standard 0-5 Vdc analog output signal.** In fact Pin 2 is normally a constant 5.12 Vdc that reflects the system bus voltage and can be used as a source for the set-point signal.



**For 6 Pin Locking Industrial Connector, DB9 and DB15 pin-outs see pages 85 to 98. For PROFIBUS pin-outs see page 83.**

## INPUT SIGNALS

### Analog Input Signal

Apply analog input to Pin 4 as shown on page 8.

**For 6 Pin Locking Industrial Connector, DB9 and DB15 pin-outs see pages 85 to 98.  
For PROFIBUS pin-outs see page 82.**

**Standard 0-5 Vdc** is the standard analog input signal. Apply the 0-5 Vdc input signal to pin 4, with common ground on pin 8. The 5.12 Vdc output on pin 2 can be wired through a 50K ohm potentiometer and back to the analog input on pin 4 to create an adjustable 0-5 Vdc input signal source as shown below.

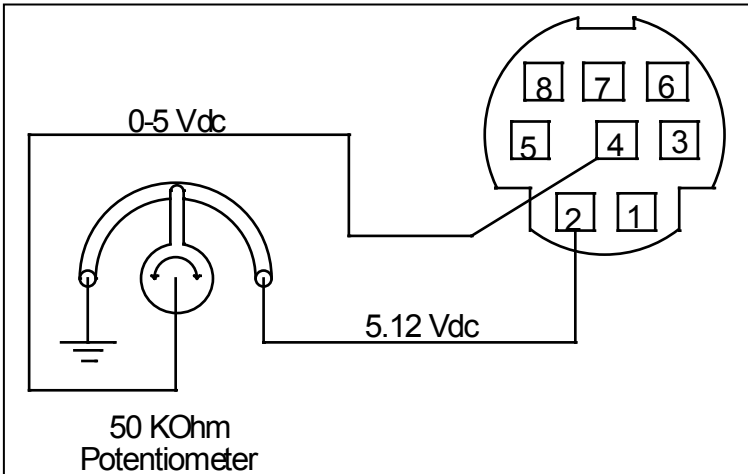

Simple method for providing set-point to controllers

**Optional 0-10 Vdc:** If specified at time of order, a 0-10 Vdc input signal can be applied to pin 4, with common ground on pin 8.

**Optional 4-20 mA:** If specified at time of order, a 4-20 mA input signal can be applied to pin 4, with common ground on pin 8.

**NOTE:** This is a current sinking device. The receiving circuit is essentially a 250 ohm resistor to ground.

**NOTE:** 4-20mA output requires at least 15 Vdc power input.



**CAUTION! DO NOT CONNECT THIS DEVICE TO "LOOP POWERED" SYSTEMS, AS THIS WILL DESTROY PORTIONS OF THE CIRCUITRY AND VOID THE WARRANTY. IF YOU MUST INTERFACE WITH EXISTING LOOP POWERED SYSTEMS, ALWAYS USE A SIGNAL ISOLATOR AND A SEPARATE POWER SUPPLY.**

## RS-232 / RS-485 Digital Input Signal

To use the RS-232 or RS-485 input signal, connect the RS-232 / RS-485 Output Signal (Pin 5), the RS-232 / RS-485 Input Signal (Pin 3), and Ground (Pin 8) to your computer serial port as shown below. (See page 33 for details on accessing RS-232 / RS-485 input.)

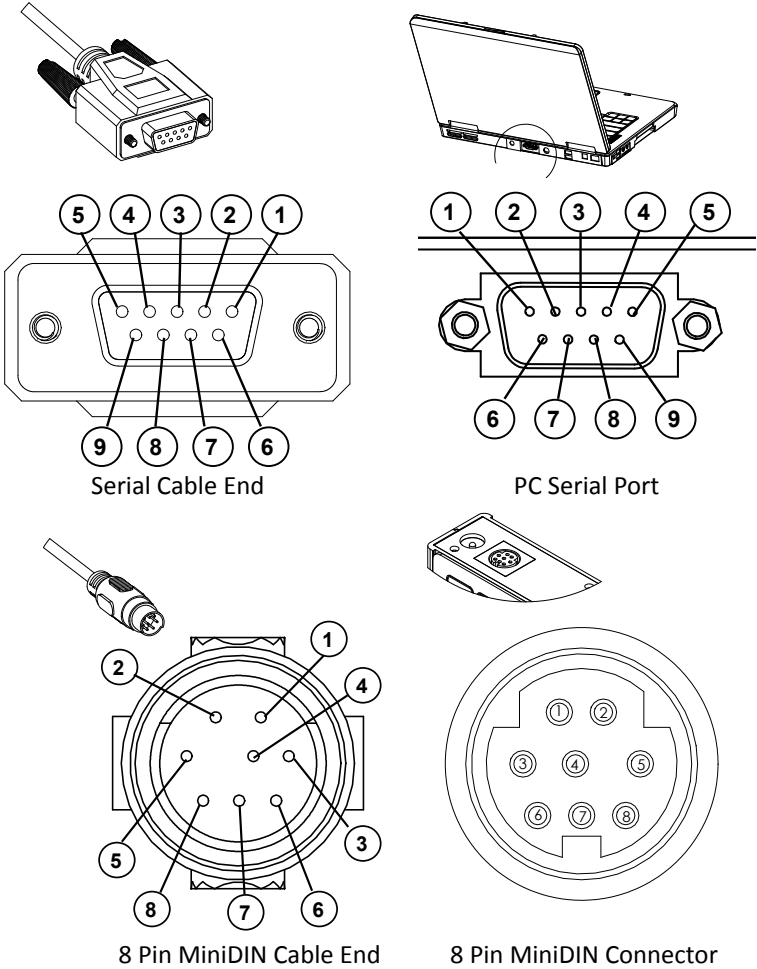

| 9 Pin Serial Connection |          | 8 Pin MiniDIN Connection |     |
|-------------------------|----------|--------------------------|-----|
| Pin                     | Function | Function                 | Pin |
| 5                       | Ground   | Ground                   | 8   |
| 3                       | Transmit | Receive                  | 3   |
| 2                       | Receive  | Transmit                 | 5   |

DB9 to Mini-DIN Connection for RS-232 / RS-485 Signals

## OUTPUT SIGNALS

### RS-232 / RS-485 Digital Output Signal

To use the RS-232 or RS-485 output signal, it is necessary to connect the RS-232 / RS-485 Output Signal (Pin 5), the RS-232 / RS-485 Input Signal (Pin 3), and Ground (Pin 8) to your computer serial port as shown on page 8. (See page 33 for details on accessing RS-232 / RS-485 output.)

### Standard Voltage (0-5 Vdc) Output Signal

MC-Series flow controllers equipped with a 0-5 Vdc (optional 0-10 Vdc) will have this output signal available on Pin 6. This output is generally available in addition to other optionally ordered outputs. This voltage is usually in the range of 0.010 Vdc for zero flow and 5.0 Vdc for full-scale flow. The output voltage is linear over the entire range. Ground for this signal is common on Pin 8.

### Optional 0-10 Vdc Output Signal

If your controller was ordered with a 0-10 Vdc output signal, it will be available on Pin 6. (See the Calibration Data Sheet that shipped with your controller to determine which output signals were ordered.) This voltage is usually in the range of 0.010 Vdc for zero flow and 10.0 Vdc for full-scale flow. The output voltage is linear over the entire range. Ground for this signal is common on Pin 8.

### Optional Current (4-20 mA) Output Signal

If your controller was ordered with a 4-20 mA current output signal, it will be available on Pin 1. (See the Calibration Data Sheet that shipped with your controller to determine which output signals were ordered.) The current signal is 4 mA at 0 flow and 20 mA at the controller's full scale flow. The output current is linear over the entire range. Ground for this signal is common on Pin 8. (Current output units require 15-30Vdc power.)

### Optional 2nd Analog Output Signal

You may specify an optional 2nd analog output on Pin 2 at time of order. (See the Calibration Data Sheet that shipped with your controller to determine which output signals were ordered.) This output may be a 0-5 Vdc, 0-10 Vdc, or 4-20 mA analog signal that can represent any measured parameter. With this optional output, a controller could output the mass flow rate (0-5 Vdc on pin 6) and the absolute pressure (0-5 Vdc on pin 2).



If your device is CSA/ATEX approved or equipped with the optional six pin industrial connector, please contact Your dealer.



**CAUTION! DO NOT CONNECT THIS DEVICE TO "LOOP POWERED" SYSTEMS, AS THIS WILL DESTROY PORTIONS OF THE CIRCUITRY AND VOID THE WARRANTY. IF YOU MUST INTERFACE WITH EXISTING LOOP POWERED SYSTEMS, ALWAYS USE A SIGNAL ISOLATOR AND A SEPARATE POWER SUPPLY.**



**CAUTION! DO NOT CONNECT THIS DEVICE TO "LOOP POWERED" SYSTEMS, AS THIS WILL DESTROY PORTIONS OF THE CIRCUITRY AND VOID THE WARRANTY. IF YOU MUST INTERFACE WITH EXISTING LOOP POWERED SYSTEMS, ALWAYS USE A SIGNAL ISOLATOR AND A SEPARATE POWER SUPPLY.**

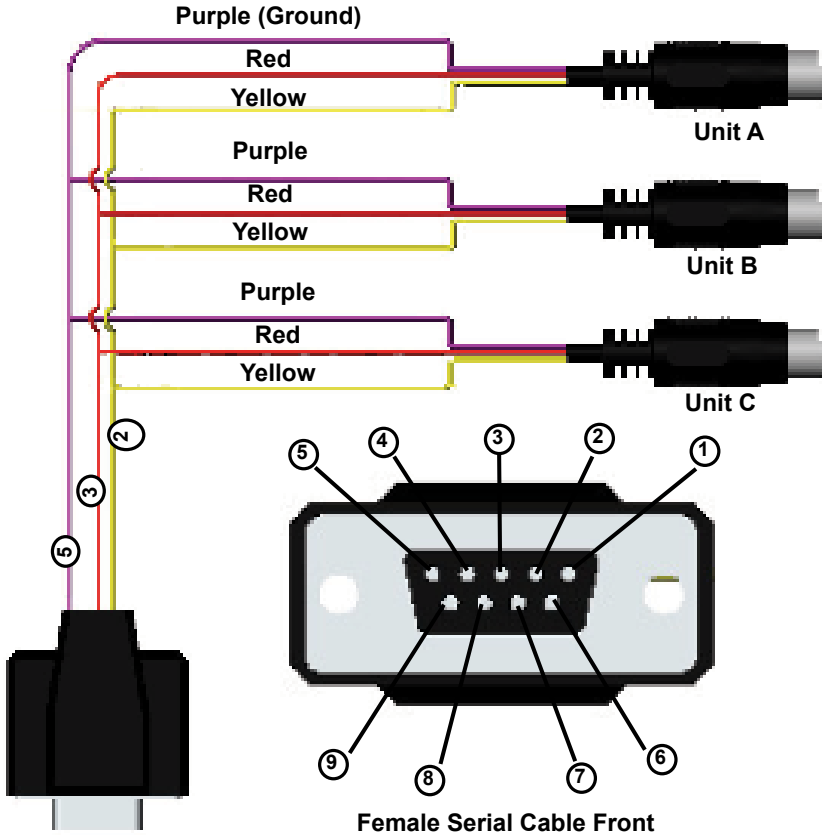

Typical Multiple Device (Addressable) Wiring Configuration



**The easiest way to connect multiple devices is with a Multi-Drop Box (see page 57).**

## Information for TFT (Color Display) Instruments

TFT (color display) instruments have a high contrast back-lit LCD display. TFT instruments operate in accordance with MC-Series standard operating instructions for our monochrome menus and displays with the following differences.

### Multi-Color Display Color Codes:

**GREEN:** Green labels identify the parameters and/or adjustments associated with the button directly above or below the label.

**WHITE:** The color of each parameter is displayed in white while operating under normal conditions.

**RED:** The color of a parameter is displayed in red when operating conditions for that parameter exceed 128% of the device's specifications.

**YELLOW:** Yellow is the equivalent of the selection arrow on the monochrome display.

### LCD Contrast:

LCD contrast is ranged from 0 to 11 on color displays with 11 being the greatest contrast.

### Display On/Off:

Pushing the button under the display will turn the device display on or off. This feature is not available on monochrome displays.

### Technical Data for TFT (Color Display) Meters, Gauges and Controllers

The following specifications are applicable to **TFT** (color display) meters, gauges and controllers only. All other operating specifications are shown in the Technical Data page for standard MC-Series instruments. All standard device features and functions are available and operate in accordance with the operating manual provided with the device.

| Specification  | Meter or Gauge                 | Small Valve Controller           | Large Valve Controller |
|----------------|--------------------------------|----------------------------------|------------------------|
| Supply Voltage | 7 to 30 Vdc                    | 12 to 30 Vdc                     | 24 to 30 Vdc           |
| Supply Current | 80 mA @ 12Vdc<br>70 mA @ 24Vdc | 290 mA @ 12Vdc<br>200 mA @ 24Vdc | 780 mA @<br>24Vdc      |

## DISPLAYS AND MENUS

The device screen defaults to **Main** display as soon as power is applied to the controller.  
Note: See page 28 to rotate the display 180°.

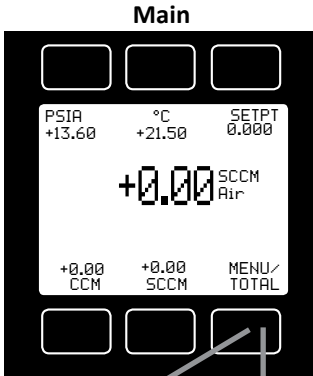

The **Main** display shows pressure, temperature, set-point, volumetric flow and mass flow.

Pressing the button adjacent to a parameter will make that parameter the primary display unit.

By hitting the **MENU** button at the bottom right of the screen you will enter the **Select Menu** display.



If your controller was ordered with the **Totalizer** option (page 54), pushing the **TOTAL** button once will bring up the **Totalizing Mode** display. Pushing **MENU** will bring up the **Select Menu** display.

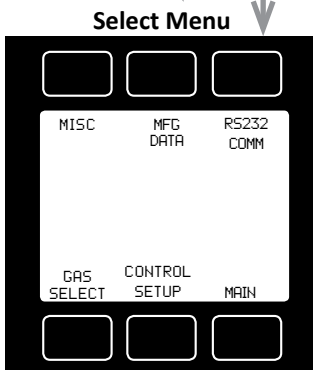

### Select Menu

From **Select Menu** you can change the selected gas, interact with your RS-232 / RS-485 settings, read manufacturer's data or access the control set-up display.

Push **MAIN** to return to the Main display.

## MAIN

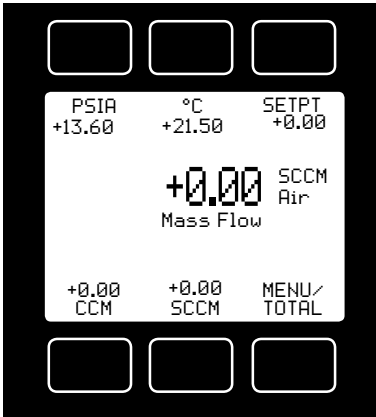

This mode defaults on power up, with mass flow as the primary displayed parameter.

The following parameters are displayed in the Main mode.

**Gas Absolute Pressure:** This sensor references hard vacuum and reads incoming pressure both above and below local atmospheric pressure. This parameter is moved to the primary display by pushing the button above **PSIA**. Pushing this button again shows unit changes.

The engineering unit associated with absolute pressure is pounds per square inch absolute (psia). This can be converted

to gage pressure (psig) by subtracting local atmospheric pressure from the absolute pressure reading:

$$\text{PSIG} = \text{PSIA} - (\text{Local Atmospheric Pressure})$$

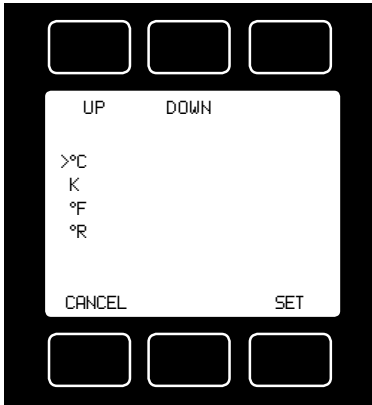

**Gas Temperature:** MC-Series flow controllers measure the incoming temperature of the gas flow. The temperature is displayed in degrees Celsius (°C). This parameter is moved to the primary display by pushing the button above °C.

Pushing the button again allows you to select °C (Celsius), K (Kelvin), °F (Fahrenheit) or °R (Rankine) for the temperature scale.

To select a temperature scale, use the UP and DOWN buttons to position the arrow in front of the desired scale.

Press SET to record your selection and return to the MAIN display. The selected

temperature scale will be displayed on the screen.

**Set Point:** The set-point (**SETPT**) is shown in the upper right of the display.

*For information on changing the set-point see SETPT SOURCE, page 18.*

**Volumetric Flow Rate:** This parameter is located in the lower left of the display. It is moved to the primary display by pushing the button below **CCM** in this example. Your display may show a different unit of measure. Pushing this button again shows unit changes.



**WHEN USING A MASS FLOW CONTROLLER AS AN ABSOLUTE PRESSURE CONTROLLER, THE MASS FLOW RATE MAY MOMENTARILY EXCEED THE FLOW MEASUREMENT CAPABILITY (FULL SCALE + 28%) OF THE UNIT. THIS MAY OCCUR WHEN THE UNIT IS ASKED TO MAKE AN ABRUPT PRESSURE CHANGE.**

**IF THE OPTIONAL TOTALIZER IS IN USE AT THAT TIME, THE TOTALIZED VALUE WILL NECESSARILY BECOME INCORRECT. PLEASE RESET THE TOTALIZER IF SUCH AN 'OVER-FLOW' CONDITION HAS OCCURRED.**

**Mass Flow Rate:** The mass flow rate is the volumetric flow rate corrected to a standard temperature and pressure (typically 14.696 psia and 25 °C).

This parameter is located in the lower middle of the display. It can be moved to the primary display by pushing the button below **SCCM** in this example. Your display may show a different unit of measure preceded by the letter **S**. Pushing this button again shows unit changes.



**To get an accurate volumetric or mass flow rate, the gas being measured must be selected. See Gas Select, page 21.**

**MENU:** Pressing **MENU** switches the screen to the **Select Menu** display.



**Flashing Error Message:** An error message (**MOV** = mass overrange, **VOV** = volumetric overrange, **POV** = pressure overrange, **TOV** = temperature overrange) flashes when a measured parameter exceeds the range of the sensor. When any item flashes, neither the flashing parameter nor the mass flow measurement is accurate. Reducing the value of the flashing parameter to within specified limits will return the unit to normal operation and accuracy.

**If the unit does not return to normal operation contact Your dealer.**

## SELECT MENU

From Select Menu you can change the selected gas, interact with your RS-232 / RS-485 settings, read manufacturer's data and access the control setup and miscellaneous screens.

Press the button next to the desired operation to bring that function to the screen.

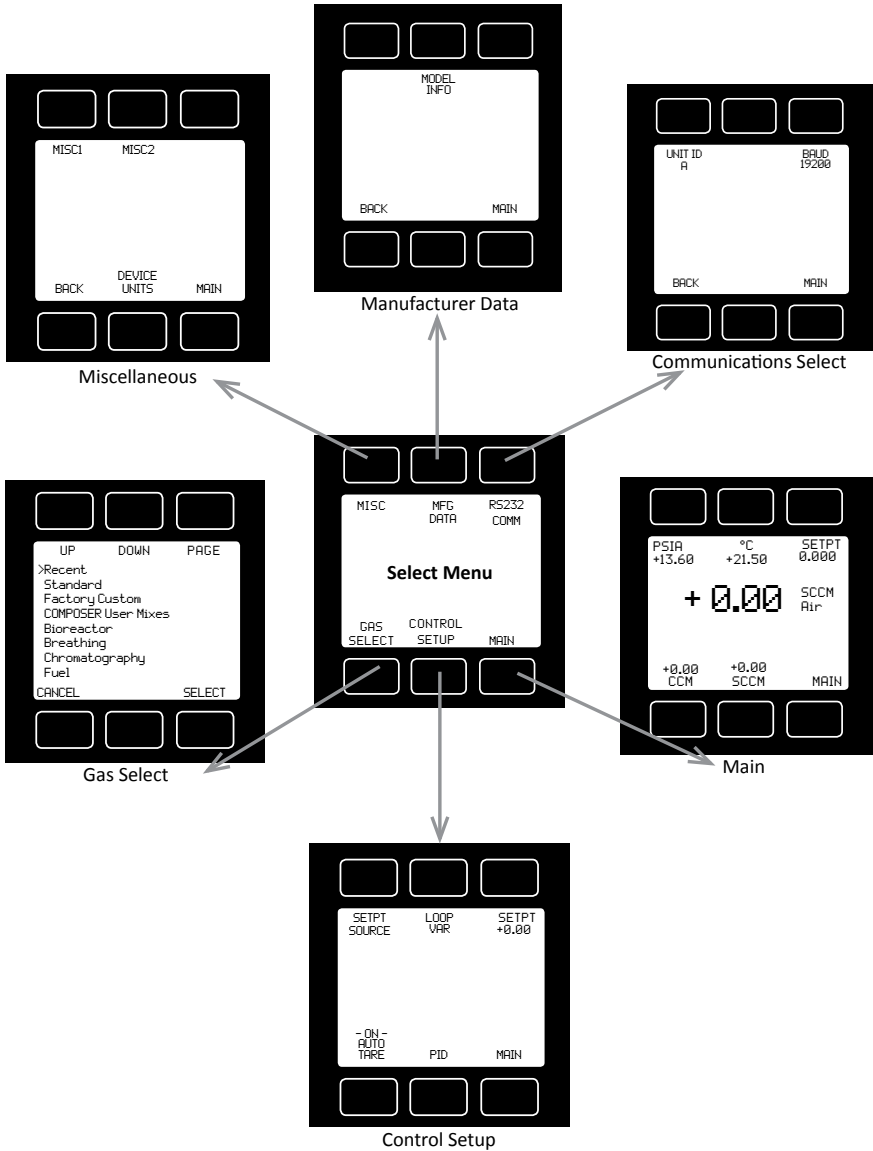

An explanation for each screen can be found on the following pages.

## CONTROL SETUP

**Control Setup** is accessed by pressing the button below Control Setup on the Select Menu display. From this screen you can select your set-point source, choose a loop variable and adjust the PID terms.

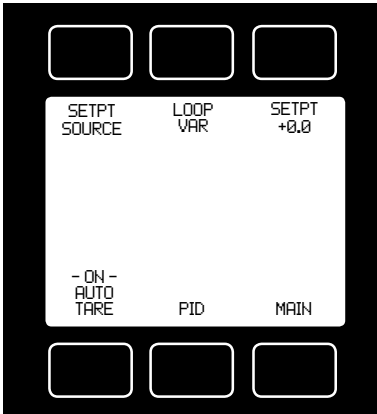

Press BACK to return to the Select Menu display.

Press MAIN to return to the MAIN display

**SETPT SOURCE** – Pressing the button above SETPT SOURCE will allow you to select how the set point will be conveyed to your controller.

Use the line-up and line-down buttons to move the arrow in front of the desired option. Then press SET.

Press CANCEL to return to the previous display.

The controller will ignore any set-point except that of the selected set-point source and it will remember which input is selected even if the power is disconnected.

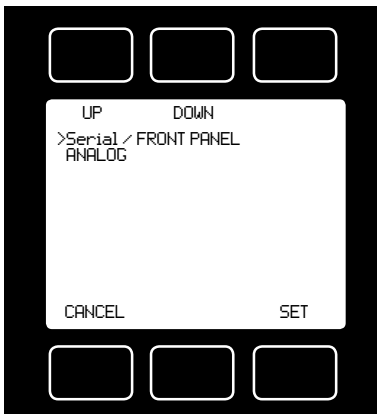

**Serial** refers to a remote digital RS-232 / RS-485 set-point applied via a serial connection to a computer or PLC as described in the installation and RS-232 / RS-485 sections of this manual.

**Front Panel** refers to a set-point applied directly at the controller.

 **Front Panel input must be selected prior to changing the set-point at the device.**

**Analog** refers to a remote analog set-point applied to Pin 4 of the Mini-DIN connector as described in the installation

section of this manual. **The standard analog input is 0-5 Vdc.**

 **To determine what type of analog set-point your controller has, refer to the Calibration Data Sheet that was included with your controller.**

If nothing is connected to Pin 4, and the controller is set for analog control, the device will generate random set-point values.

**NOTE:** If your controller has the IPC (Integrated Potentiometer Control) option, the IPC dial will operate with the ANALOG set-point source selected.

**SETPT** refers to the **set-point**. This parameter may be changed using the display only if **FRONT PANEL** is selected as the Input. Press **SETPT**. Then use SELECT to choose the decimal with the arrow and the UP and DOWN buttons to change the value. Press SET to record your value. Press CLEAR to return to zero.



**CAUTION! NEVER LEAVE A CONTROLLER WITH A NON-ZERO SET-POINT IF NO PRESSURE IS AVAILABLE TO MAKE FLOW. THE CONTROLLER WILL APPLY FULL POWER TO THE VALVE IN AN ATTEMPT TO REACH THE SET-POINT. WHEN THERE IS NO FLOW, THIS CAN MAKE THE VALVE VERY HOT!**

## CONTROL SETUP (continued)

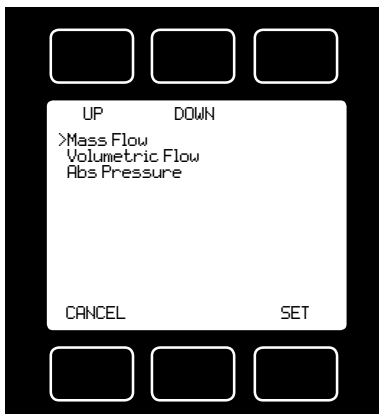
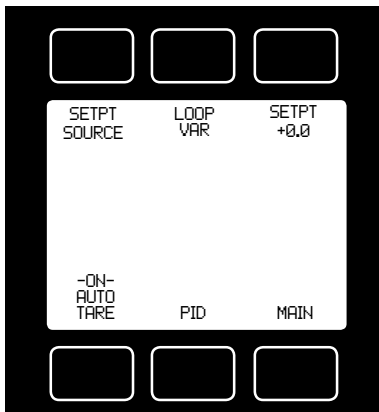

**LOOP VAR**—The selection of what variable to close the loop on is a feature unique to MC-Series mass flow controllers.

Pressing the **LOOP VAR** button on the Control Setup screen will allow you to change what variable is controlled.

Use the line-up and line-down buttons to move the arrow in front of the desired option.

When the mass flow controller is supplied with the **control valve upstream** of the electronics portion of the system, the unit can be set to control on outlet pressure (absolute pressures only) or volumetric flow rate, instead of mass flow rate.

The change from mass to volume can usually be accomplished without much, if any, change in the P and D settings.



***When you change from controlling flow to controlling pressure, sometimes fairly radical changes must be made to the P & D variables. See page 20 – PID TUNING.***

*Contact Your dealer if you are having difficulties with this procedure.*

**ON AUTO TARE/ OFF AUTO TARE**—refers to the standard auto-tare or “auto-zero” feature.

The auto-tare feature automatically tares (takes the detected signal as zero) the unit when it receives a zero set-point for more than two seconds.

A zero set-point results in the closing of the valve and a known “no flow” condition. This feature makes the device more accurate by periodically removing any cumulative errors associated with drift.



***It is recommended that the controller be left in the default auto-tare ON mode unless your specific application requires that it be turned off.***

## PID TUNING

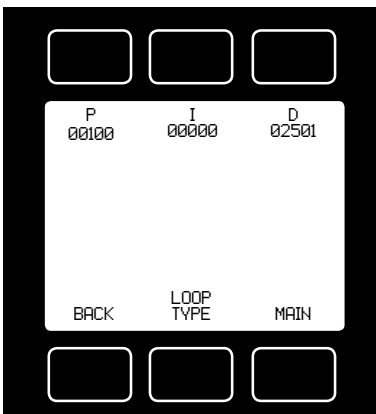
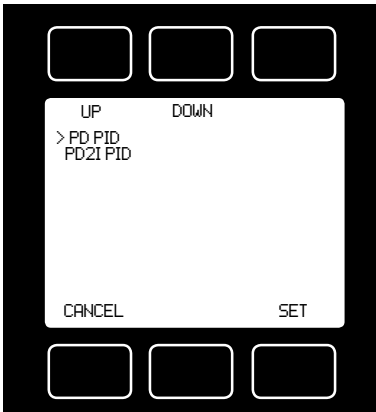
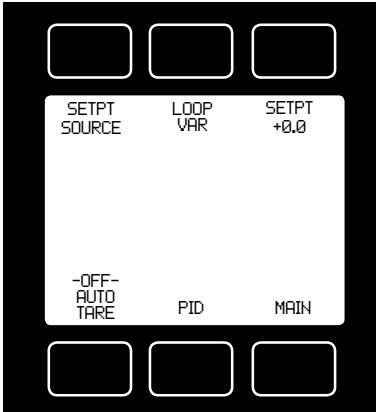

PID Values determine the performance and operation of your proportional control valve. These terms dictate control speed, control stability, overshoot and oscillation. All units leave the factory with a generic tuning designed to handle most applications. If you encounter issues with valve stability, oscillation or speed, fine tuning these parameters may resolve the problem.

MC-Series controllers allow you to adjust the Proportional, Integral and Differential terms of the PID control loop.

To change the PID loop parameters, push the button below **PID**.

Press **LOOP TYPE**. Then use the UP and DOWN buttons to select the appropriate PID control algorithm. Press SET.

**See the following page for descriptions of the PID Loop Types (PID Control Algorithms).**

**P** refers to the Proportional term of the PID loop.

**I** refers to the Integral term of the PID loop.

**D** refers to the Differential term of the PID loop.

Press P, I or D. Then use SELECT to choose the digit with the arrow and the UP and DOWN buttons to change the value. Press SET to record your value. Press CLEAR to return to zero.



**Before changing the P, I or D parameter, please record the initial value so that it can be returned to the factory setting if necessary.**

**Valve tuning can be complex. If you would like assistance, please contact Your dealer for technical support.**

***The PD algorithm is the PID algorithm used on most MC-Series controllers.***

It is divided into two segments:

The first compares the process value to the set-point to generate a proportional error. The proportional error is multiplied by the 'P' gain, with the result added to the output drive register.

The second operates on the present process value minus the process value during the immediately previous evaluation cycle. This 'velocity' term is multiplied by the 'D' gain, with the result subtracted from the output drive register.

The above additions to and subtractions from the output drive register are carried over from process cycle to process cycle, thus performing the integration function automatically.

Increasing the 'P' gain will **promote** the tendency of the system to overshoot, ring, or oscillate.

Increasing the 'D' gain will **reduce** the tendency of the system to overshoot.

***The PD21 algorithm is a PID algorithm used primarily for high performance pressure and flow control applications.***

It exhibits two basic differences from the PD algorithm that most controllers utilize.

1. Instead of applying a damping function based upon the rate of change of the process value, it applies a damping function based upon the square of the rate of change of the process value.
2. The damping function is applied directly to the proportional error term before that term is used in the proportional and integral functions of the algorithm. This provides a certain amount of 'look ahead' capability in the control loop.

*Because of these differences, you will note the following:*

1. Increasing 'P' gain can be used to damp out overshoot and slow oscillations in pressure controllers. You will know that 'P' gain is too high, when the controller breaks into fast oscillations on step changes in set-point. On flow controllers, too high a 'P' gain results in slower response times. Too low a 'P' gain results in overshoot and/or slow oscillation. A good starting value for 'P' gain is 200.
2. If the unit was originally shipped with the PD21 algorithm selected, the 'D' gain value should be left at or near the factory setting because it relates primarily to the system phase lags. If you are changing from the default algorithm to the PD21 algorithm, you should start with a 'D' gain value of 20.
3. The 'I' gain is used to control the rate at which the process converges to the set-point, after the initial step change. Too low a value for 'I' gain shows up as a process value that jumps to near the set-point and then takes awhile to converge the rest of the way. Too high a value for 'I' gain results in oscillation. A good starting value for the 'I' gain is 200.

## GAS SELECT

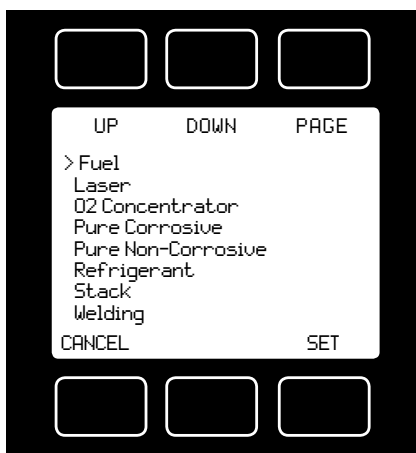
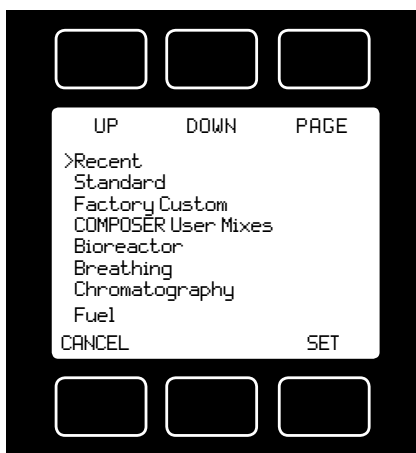

**Gas Select** allows you to set your device to up to 150 standard gases and mixes. You can also use **COMPOSER** to program and store up to 20 additional gas mixes.

**Gas Select** is accessed by pressing the button below **GAS SELECT** on the Select Menu display.

To select a gas, use the UP and DOWN buttons to position the arrow in front of the desired gas category.

- » Recent: Eight most recent selections
- » Standard: Gases and mixes standard on earlier MC-Series instruments (page 40)
- » Factory Custom: Present only if customer requested gases were added at the factory
- » COMPOSER User Mixes: Gas mixes programmed by the user (page 23)
- » Bioreactor (page 44)
- » Breathing (page 45)
- » Chromatography (page 47)
- » Fuel (page 46)
- » Laser (page 46)
- » O2 Concentrator (page 47)
- » Pure Corrosive\* (page 41)
- » Pure Non-Corrosive (page 40)
- » Refrigerant\* (page 42)
- » Stack (page 47)
- » Welding (page 43)

Press PAGE to view a new page in the gas category list.

Press SELECT to view the gases in the selected category. Align the arrow with the desired gas. Press SET to record your selection and return to the MAIN display. The selected gas will be displayed on the screen.

\* Pure Corrosive and Refrigerant gases are only available on **S-Series** instruments that are compatible with these gases.

**Note:** Gas Select may not be available on units ordered with a custom gas or blend.

**See pages 41 -48 for a full list of gases in each category.**

## COMPOSER

UP DOWN  
>Add Mix: 20 Free

CANCEL SET

This screenshot shows the initial 'Add Mix' screen. At the top, there are three empty button slots. The main display area contains the text 'UP DOWN' at the top, followed by '>Add Mix: 20 Free'. At the bottom of the display area, there are two buttons labeled 'CANCEL' and 'SET'.

UP DOWN NEXT LETTER

COMPOSER Mix name:

MyGas  
-----A

BACK/CANCEL CHANGE CASE SET

This screenshot shows the 'Mix name' screen. At the top, there are three empty button slots. The main display area contains the text 'UP DOWN NEXT LETTER' at the top, followed by 'COMPOSER Mix name:'. Below this, the name 'MyGas' is displayed with a cursor and a list of characters '-----A'. At the bottom of the display area, there are three buttons labeled 'BACK/CANCEL', 'CHANGE CASE', and 'SET'.

EDIT NAME ADD GAS GAS OPTNS

COMPOSER Mix: MyGAS

0.00% of Total

BACK/CANCEL CHANGE CASE SET

This screenshot shows the 'Add Gas' screen. At the top, there are three empty button slots. The main display area contains the text 'EDIT NAME ADD GAS GAS OPTNS' at the top, followed by 'COMPOSER Mix: MyGAS'. Below this, the text '0.00% of Total' is displayed. At the bottom of the display area, there are three buttons labeled 'BACK/CANCEL', 'CHANGE CASE', and 'SET'.

**Composer** allows you to program and save up to 20 custom gas mixes containing 2 to 5 component gases found in the gas lists (pages 40-47). The minimum resolution is 0.01%.

**Composer** is accessed by selecting **COMPOSER User Mixes** on the GAS SELECT display.

Press SET when the arrow is aligned with Add Mix.

Name the mix by pressing the UP and DOWN buttons for letters, numerals and symbols.

**CHANGE CASE** – Toggles the letter case. Letters remain in selected case until CHANGE CASE is pushed again.

Press SET to save the name.

After naming the mix, press **ADD GAS** and select the gas category and the component gas.

Select the digit with arrow and adjust the % with the UP and DOWN buttons. Press set to save. Add up to 4 more gases as needed. The total must equal 100% or an error message will appear.

**GAS OPTNS** allows you to adjust the percentage of the constituents or delete a gas from the mix. Gas mixes cannot be adjusted after they have been saved.

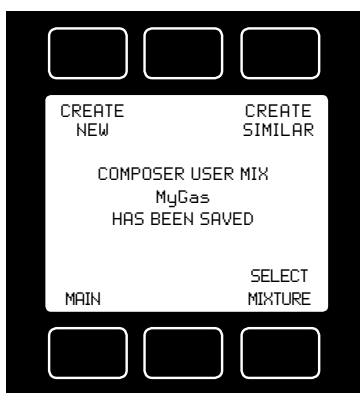
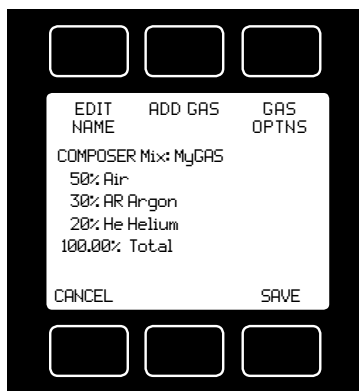
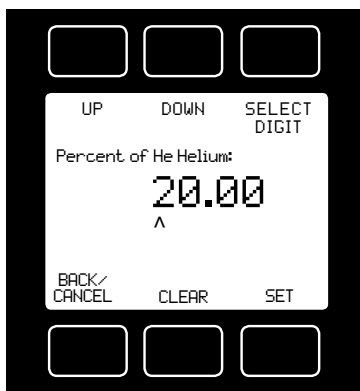
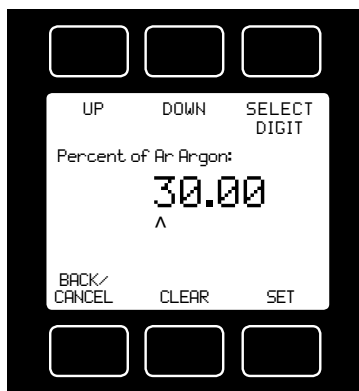
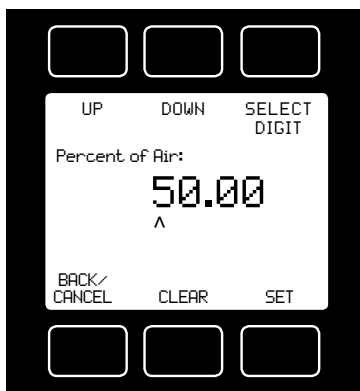

Once the mix has been saved, you may press **CREATE SIMILAR** to compose an additional mix based on the mix you have just saved. This CREATE SIMILAR option is not available after leaving this screen.

Press **CREATE NEW** to add a completely new mix.

Press **SELECT MIXTURE** to bring the custom mix onto the MAIN display.

## COMMUNICATION SELECT

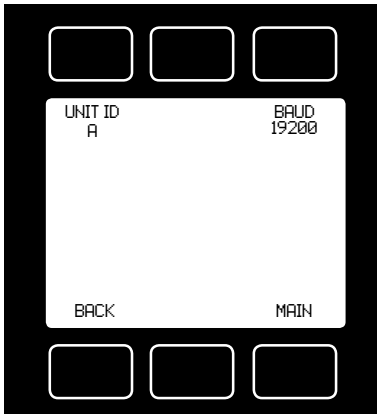

Access **Communication Select** by pressing the button above **RS232 COMM** or **RS485 COMM** on the **Select Menu** display.

**Unit ID** – Valid unit identifiers are the letters A-Z and @. The identifier allows you to assign a unique address to each device so that multiple units can be connected to a single RS-232 or RS-485 computer port.

Press **UNIT ID**. Use the UP and DOWN buttons to change the Unit ID. Press SET to record the ID. Press Reset to return to the previously recorded Unit ID.

**Any Unit ID change will take effect when Communication Select is exited.**

***If the symbol @ is selected as the Unit ID, the device will enter streaming mode when Communication Select is exited. See RS-232 Communications (page 33) for information about the streaming mode.***

**Baud** – Both this instrument and your computer must send/receive data at the same baud rate. The default baud rate for this device is 19200 baud.

Press **BAUD**. Use the UP and DOWN buttons to select the baud rate that matches your computer. The choices are 38400, 19200, 9600, or 2400 baud. Press SET to record the baud rate.

**Any baud rate change will not take effect until power to the unit is cycled.**

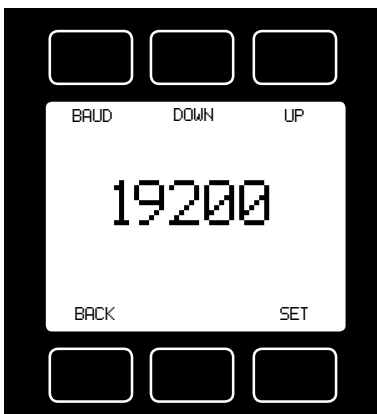
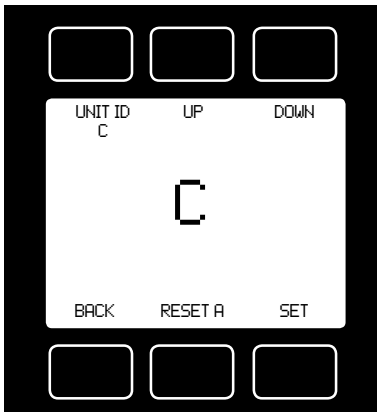

## MISCELLANEOUS

**Miscellaneous** is accessed by pressing the **MISC** button on the Select Menu display. Next select either **MISC1** or **MISC2**.

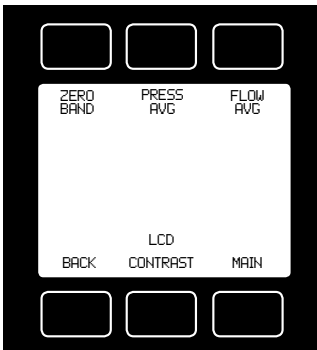

**MISC1** will display as shown at left.

**ZERO BAND** refers to Display Zero Deadband.

Zero deadband is a value below which the display jumps to zero. This deadband is often desired to prevent electrical noise from showing up on the display as minor flows or pressures that do not exist. Display Zero Deadband does not affect the analog or digital signal outputs.

**ZERO BAND** can be adjusted between 0 and 6.3% of the sensor's Full Scale (FS).

Press **ZERO BAND**. Then use SELECT to choose the digit with the arrow and the UP and DOWN buttons to change the value. Press SET to record your value. Press CLEAR to return to zero.

**Pressure Averaging and Flow Averaging** may be useful to make it easier to read and interpret rapidly fluctuating pressures and flows. Pressure and flow averaging can be adjusted between 1 (no averaging) and 256 (maximum averaging).

These are geometric running averages where the number between 1 and 256 can be considered roughly equivalent to the response time constant in milliseconds.

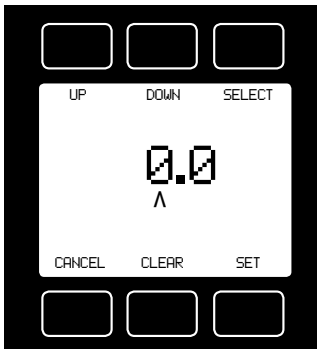

This can be effective at "smoothing" high frequency process oscillations such as those caused by diaphragm pumps.

Press **PRESS AVG**. Then use SELECT to choose the digit with the arrow and the UP and DOWN buttons to change the value. Press SET to record your value. Press CLEAR to return to zero.

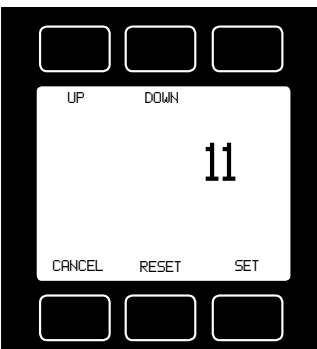

Press **FLOW AVG**. Then use SELECT to choose the digit with the arrow and the UP and DOWN buttons to change the value. Press SET to record your value. Press CLEAR to return to zero.

Setting a higher number will equal a smoother display.

**LCD CONTRAST:** The display contrast can be adjusted between 0 and 31, with zero being the lightest and 31 being the darkest. Use the UP and DOWN buttons to adjust the contrast. Press SET when you are satisfied. Press CANCEL to return to the MISC display.

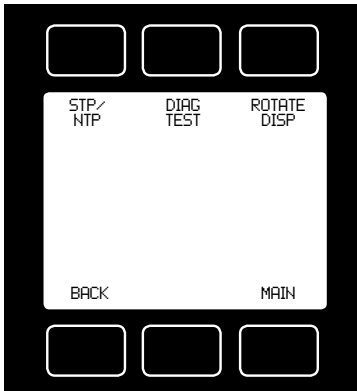

**MISC2** will display as shown at left.

**STP/NPT** refers to the functions that allow your selection of *standard* temperature and pressure conditions or *normal* temperature and pressure conditions. This feature is generally useful for comparison purposes to other devices or systems using different STP parameters.

The **STP** menu is comprised of the **STP TEMP** and **STP PRESS** screens.

**STP TEMP** allows you to select from °C, °F, K or °R. The arrow position will automatically default to the currently stored value.

The **NTP** menu is comprised of the **NTP TEMP** and **NTP PRESS** screens.

Once a selection has been made and recorded using the **SET** button, a change acknowledgement message will be displayed on screen.

Selecting **MAIN** will revert screen to the Main display. If the **SET** selection is already the currently stored value, a message indicating that fact will appear.

**STP PRESS** enables you to select from a menu pressure settings. Use the UP/DOWN or PAGE buttons to view the settings.

The arrow position will automatically default to the currently stored value.

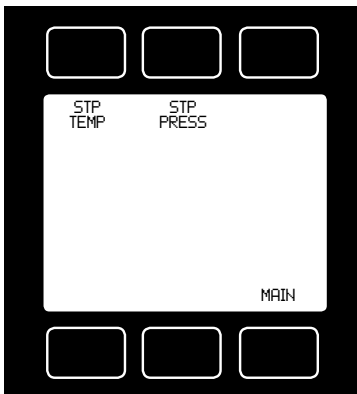

Once a selection has been made and recorded using the **SET** button, a change acknowledgement message will be displayed on screen.

Pressing **SET** again will revert screen to the Main display. If the **SET** selection is already the currently stored value, a message indicating that fact will appear.

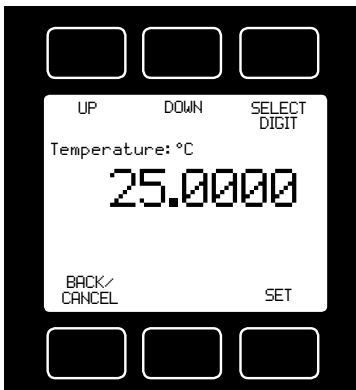

STP TEMP Display

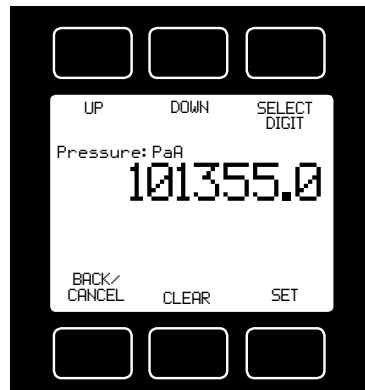

STP PRESS Display



**DIAG TEST:** This diagnostic screen displays the current internal register values, which is useful for noting factory settings prior to making any changes. It is also helpful for troubleshooting with customer service personnel.

Select the **DIAG TEST** button from the **MISC2** screen to view a list of select register values. Pressing the **SCROLL** button will cycle the display through the register screens. An example screen is shown at left.

Press **ROTATE DISP** and **SET** to **Inverted 180°** if your device is inverted. The display and buttons will rotate together.

## DEVICE UNITS

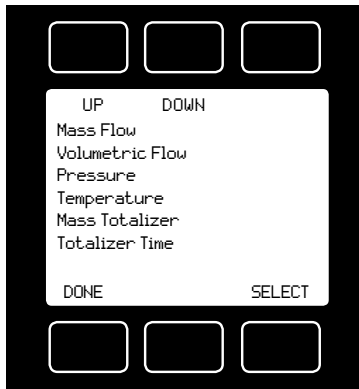

Press **DEVICE UNITS** to access menus of units of measure for each parameter (and totalizer if so equipped).

Scroll to the desired unit and press select. Once selected, you will see the message shown below. Verify that all connected devices expect the change.

See pages 49 and 50 for a full list of available units.

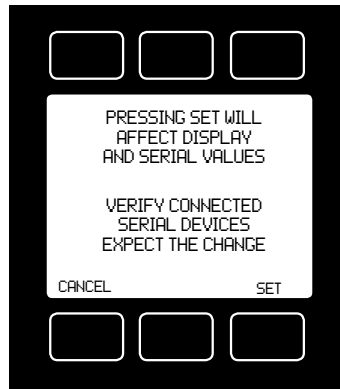
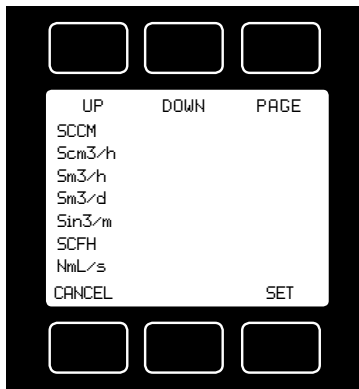

## MANUFACTURER DATA

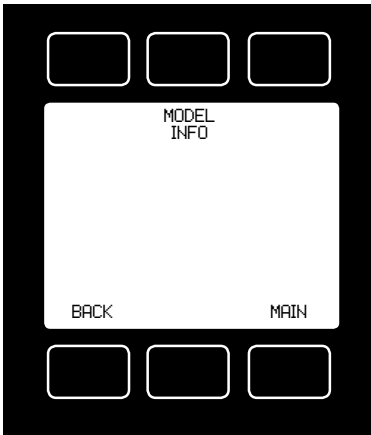

**Manufacturer Data** is accessed by pressing the **MFG DATA** button on the Select Menu display.

The initial display will be blank.

Press **MODEL INFO** to show important information about your flow device including the model number, serial number, and date of manufacture.

Press **BACK** to return to the MFG DATA display.

Push **MAIN** to return to the Main display.

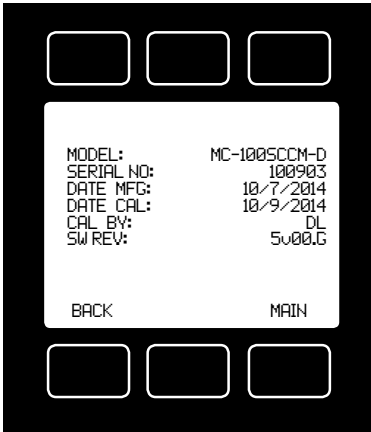

## MCV Controller Operating Notes

The MCV mass flow controller is equipped with an integrated Swagelok® positive shutoff valve.

The normally closed valve is air actuated and will remain closed until it is connected to an air source supplying between 60 and 120 psig of air pressure. Once the appropriate amount of air pressure is supplied to the shutoff valve, it will open, allowing flow through the mass controller. Air pressure must be removed from the shutoff valve in order for the valve to close.

A common method for actuating the shutoff valve incorporates a three-way solenoid valve (below).

Air pressure is applied to one side of the solenoid valve while the other side of the solenoid is left open to atmosphere.

When the solenoid is energized, air pressure is delivered to the shutoff valve, allowing it to open.

When the solenoid is returned to a relaxed state, air pressure is removed from the shutoff valve, allowing it to close. The air pressure is vented to atmosphere.

**Note:** All standard MC-Series device features and functions are available on the MCV-Series and operate in accordance with the standard MC-Series operating instructions.

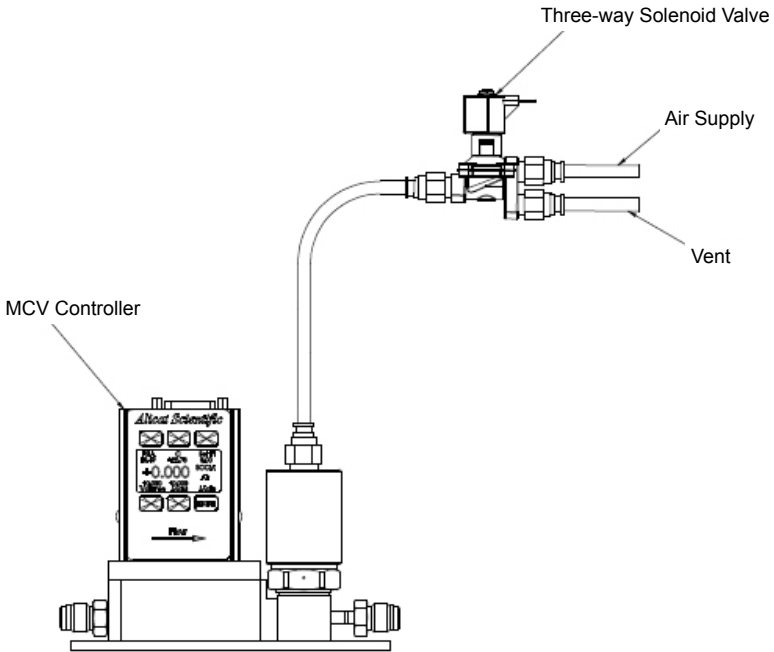

MCV controller and three-way solenoid valve.

## MCD Dual Valve Mass Controller Operating Notes

The MCD is a versatile Dual-Valve Mass Flow and Pressure Controller. It can be used to:

- Measure mass flow and volumetric flow in both directions, plus absolute pressure and temperature;
- Control mass or volumetric flow from a pressurized source or to vacuum;
- Control absolute pressure or back-pressure in a flowing process;
- Control absolute pressure in a closed volume with automatic venting.

Application examples are shown below and on the following page. Please contact Your dealer if you have any questions regarding MCD use.

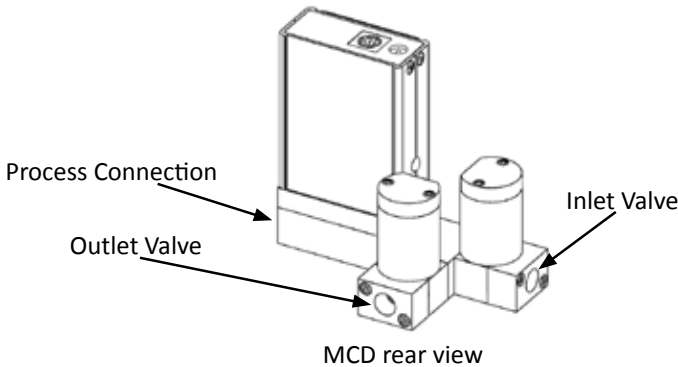
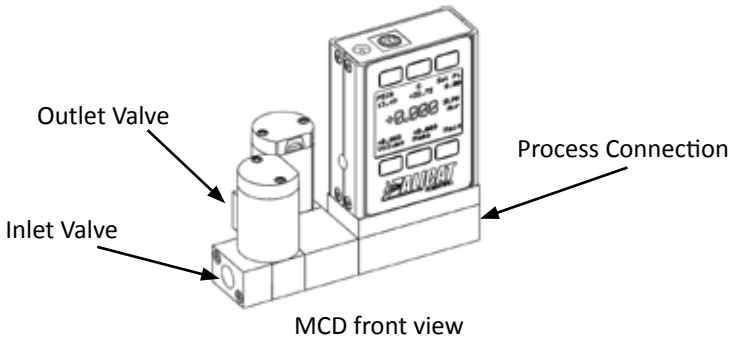

### Mass Flow (or Volumetric Flow) Control

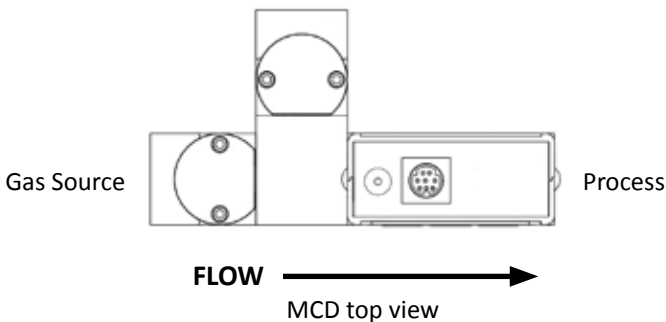

### Inverse Mass Flow (or Volumetric Flow) Control with Vacuum

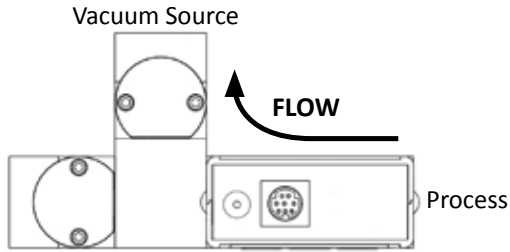

### Bidirectional Mass Flow (or Volumetric Flow) Control

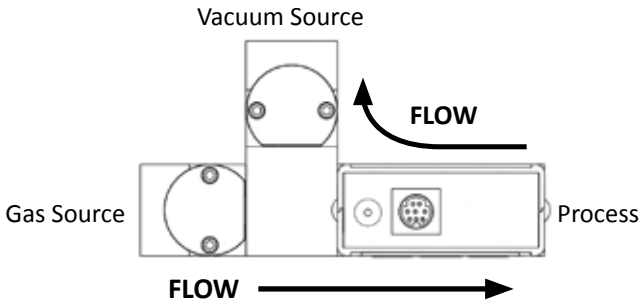

### Flowing Absolute Pressure Control

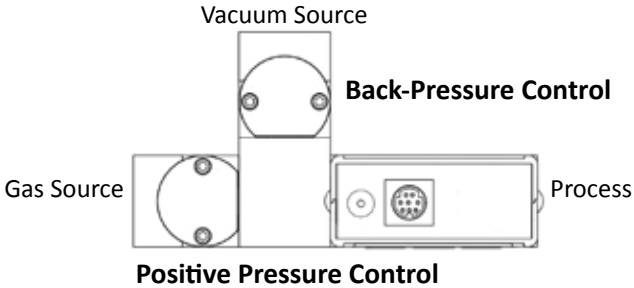

### Dead-Ended Absolute Pressure Control

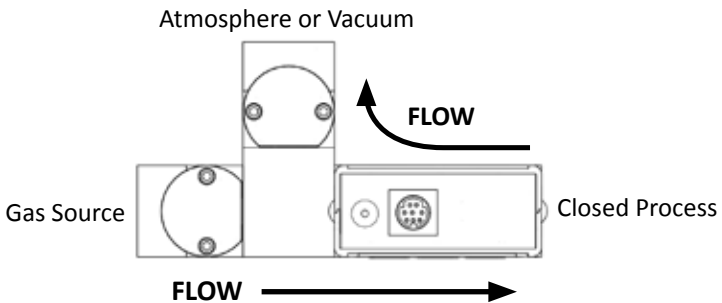

## RS-232 / RS-485 Output and Input

### Configuring HyperTerminal®:

1. Open your HyperTerminal® RS-232 / RS-485 terminal program (installed under the “Accessories” menu on all Microsoft Windows® operating systems).
2. Select “Properties” from the file menu.
3. Click on the “Configure” button under the “Connect To” tab. Be sure the program is set for: 19,200 baud (or matches the baud rate selected in the RS-232 / RS-485 communications menu on the meter) and an 8-N-1-None (8 Data Bits, No Parity, 1 Stop Bit, and no Flow Control) protocol.
4. Under the “Settings” tab, make sure the Terminal Emulation is set to ANSI or Auto Detect.
5. Click on the “ASCII Setup” button and be sure the “Send Line Ends with Line Feeds” box is not checked and the “Echo Typed Characters Locally” box and the “Append Line Feeds to Incoming Lines” boxes are checked. Those settings not mentioned here are normally okay in the default position.
6. Save the settings, close HyperTerminal® and reopen it.

### Streaming Mode (RS-485 units do not have a streaming mode)

In the **default** Polling Mode, the screen should be blank except the blinking cursor. In order to get the data streaming to the screen, hit the “Enter” key several times to clear any extraneous information. Type “\* @= @” followed by “Enter” (or using the RS-232 / RS-485 communication select menu, select @ as identifier and exit the screen). If data still does not appear, check all the connections and COM port assignments.

### Streaming Mode – Advanced

The streaming data rate is controlled by register 91. The recommended default rate of data provision is once every 50 milliseconds and this is suitable for most purposes. If a slower or faster streaming data rate is desired, register 91 can be changed to a value from 1 millisecond to 65535 milliseconds, or slightly over once every minute. Below approximately 40 milliseconds, data provision will be dependent upon how many parameters are selected. Fewer data parameters can be streamed more quickly than more. It is left to the user to balance streaming speed with number of parameters streamed.

To read register 91, type “\*r91” followed by “Enter”.

To modify register 91, type “\*w91=X”, where X is a positive integer from 1 to 65535, followed by “Enter”.

To return to the recommended factory default streaming speed, type “\*w91= 50”.

### Changing From Streaming to Polling Mode:

When the meter is in the Streaming Mode (*RS-485 units do not have a streaming mode*), the screen is updated approximately 10-60 times per second (depending on the amount of data on each line) so that the user sees the data essentially in real time. It is sometimes desirable, and necessary when using more than one unit on a single RS-232 line, to be able to poll the unit.

In Polling Mode the unit measures the flow normally, but only sends a line of data when it is “polled”. Each unit can be given its own unique identifier or address.

Unless otherwise specified each unit is shipped with a default address of capital A. Other valid addresses are B thru Z.

Once you have established communication with the unit and have a stream of information filling your screen:

1. Type `*@=A` followed by “Enter” (or using the RS-232 / RS-485 communication select menu, select A as identifier and exit the screen) to stop the streaming mode of information. Note that the flow of information will not stop while you are typing and you will not be able to read what you have typed. Also, the unit does not accept a backspace or delete in the line so it must be typed correctly. If in doubt, simply hit enter and start again. If the unit does not get exactly what it is expecting, it will ignore it. If the line has been typed correctly, the data will stop.
2. You may now poll the unit by typing A followed by “Enter”. This does an instantaneous poll of unit A and returns the values once. You may type A “Enter” as many times as you like. Alternately you could resume streaming mode by typing `*@=@` followed by “Enter”. Repeat step 1 to remove the unit from the streaming mode.
3. To assign the unit a new address, type `*@=New Address`, e.g. `*@=B`. Care should be taken not to assign an address to a unit if more than one unit is on the RS-232 / RS-485 line as all of the addresses will be reassigned. Instead, each should be individually attached to the RS-232 / RS-485 line, given an address, and taken off. After each unit has been given a unique address, they can all be put back on the same line and polled individually.

**Sending a Set-point via RS-232 / RS-485:** To send a set-point via RS-232 / RS-485, “Serial” must be selected under the “Input” list in the control set up mode.

**Method 1:** Set-point may be set in floating point in serial communication using serial command (UnitID)SX.YZ

Example: AS4.54 results in Unit ID A changing set-point to 4.54.

**Method 2:** Type in a number between 0 and 65535 (2% over range), where 64000 denotes full-scale flow rate, and hit “Enter”.

The set-point column and flow rates should change accordingly. If they do not, try hitting “Enter” a couple of times and repeating your command. The formula for performing a linear interpolation is as follows:

$$\text{Value} = (\text{Desired Set-point} \times 64000) / \text{Full Scale Flow Range}$$

For example, if your device is a 100 slpm full-scale unit and you wish to apply a set-point of 35 slpm you would enter the following value:

$$22400 = (35 \text{ slpm} \times 64000) / 100 \text{ slpm}$$

If the controller is in polling mode as described in *Changing from Streaming Mode to Polling Mode*, the set-point must be preceded by the address of the controller. For example, if your controller has been given an address of D, the set-point above would be sent by typing:

D22400 followed by “Enter”

### To adjust the Proportional and Differential (P&D) terms via RS-232 / RS-485:

Type \*@=A followed by “Enter” to stop the streaming mode of information.

To adjust the “P” or proportional term of the PID controller, type \*R21 followed by “Enter”.

The computer will respond by reading the current value for register 21 between 0-65535. It is good practice to write this value down so you can return to the factory settings if necessary. Enter the value you wish to try by writing the new value to register 21. For example, if you wished to try a “P” term of 220, you would type \*W21=**220** followed by “Enter” where the bold number denotes the new value.

The computer will respond to the new value by confirming that 21=220. To see the effect of the change you may now poll the unit by typing A followed by “Enter”. This does an instantaneous poll and returns the values once. You may type A “Enter” as many times as you like. Alternately you could resume streaming mode by typing \*@=@ followed by “Enter”. Repeat step 3 to remove the unit from the streaming mode.

To adjust the “D” or proportional term of the PID controller, type \*R22 followed by “Enter”.

The computer will respond by reading the current value for register 22 between 0-65535. It is good practice to write this value down so you can return to the factory settings if necessary. Enter the value you wish to try by writing the new value to register 22. For example, if you wished to try a “D” term of 25, you would type \*W22=**25** followed by “Enter” where the bold number denotes the new value.

The computer will respond to the new value by confirming that 22=25. To see the effect of the change you may now poll the unit by typing A followed by “Enter”. This does an instantaneous poll and returns the values once. You may type A “Enter” as many times as you like. Alternately you could resume streaming mode by typing \*@=@ followed by “Enter”. Repeat.

You may test your settings for a step change by changing the set-point. To do this type A32000 (A is the default single unit address, if you have multiple addressed units on your RS-232 / RS-485 line the letter preceding the value would change accordingly.) followed by “Enter” to give the unit a ½ full scale set-point. Monitor the unit’s response to the step change to ensure it is satisfactory for your needs. Recall that the “P” term controls how quickly the unit goes from one set-point to the next, and the “D” term controls how quickly the signal begins to “decelerate” as it approaches the new set-point (controls the overshoot).

**Gas Select** – The selected gas can be changed via RS-232 / RS-485 input. To change the selected gas, enter the following commands:

In Polling Mode: Address\$\$#<Enter> (e.g. B\$\$#<Enter>)

Where # is the number of the gas selected from the table below. Note that this also corresponds to the gas select menu on the flow controller screen (the **Standard** gas category is shown in the example below):

| #  | GAS   |         |
|----|---|---------|
| 0  | Air   | Air     |
| 1  | Argon   | Ar      |
| 2  | Methane   | CH4     |
| 3  | Carbon Monoxide   | CO      |
| 4  | Carbon Dioxide  | CO2     |
| 5  | Ethane  | C2H6    |
| 6  | Hydrogen  | H2      |
| 7  | Helium  | He      |
| 8  | Nitrogen  | N2      |
| 9  | Nitrous Oxide   | N2O     |
| 10 | Neon  | Ne      |
| 11 | Oxygen  | O2      |
| 12 | Propane   | C3H8    |
| 13 | normal-Butane   | n-C4H10 |
| 14 | Acetylene   | C2H2    |
| 15 | Ethylene  | C2H4    |
| 16 | iso-Butane  | i-C4H10 |
| 17 | Krypton   | Kr      |
| 18 | Xenon   | Xe      |
| 19 | Sulfur Hexafluoride   | SF6     |
| 20 | 75% Argon / 25% CO2   | C-25    |
| 21 | 90% Argon / 10% CO2   | C-10    |
| 22 | 92% Argon / 8% CO2  | C-8     |
| 23 | 98% Argon / 2% CO2  | C-2     |
| 24 | 75% CO2 / 25% Argon   | C-75    |
| 25 | 75% Argon / 25% Helium  | HE-75   |
| 26 | 75% Helium / 25% Argon  | HE-25   |
| 27 | 90% Helium / 7.5% Argon / 2.5% CO2<br>(Praxair - Helistar® A1025) | A1025   |
| 28 | 90% Argon / 8% CO2 / 2% Oxygen<br>(Praxair - Stargon® CS)         | Star29  |
| 29 | 95% Argon / 5% Methane  | P-5     |

For example, to select Propane, enter: \$\$12<Enter>

## Creating and Deleting Gas Mixtures with COMPOSER™ using RS-232 or RS-485

**Note:** All commands must be prefixed with the unit ID letter. The unit should not be in streaming mode.

You may create and store up to 20 gas mixtures containing up to five constituent gases each. The constituent gases must be chosen from the existing list of gases installed on the device (which may vary model to model). Please see pages 40 – 47 for lists of gases and their corresponding gas numbers.

### Create a Gas Mixture

To create a gas mixture, enter a single-line command according to the following formula:  
[Unit ID] GM [Gas Name] [Gas Mix Number] [Percent 1] [Gas Number 1]  
[Percent 2] [Gas Number 2] ...etc. etc.

**Notes:** Do not type the brackets. There should be only one space between all items. Any percentages less than 1, should have a leading zero before the decimal (i.e. 0.25 for .25%). Trailing zeros are not necessary but they are allowed to help visualize the percentages on screen (as in the example). The sum of all percentages must be 100.00 otherwise an error will occur.

Here is an example of a three gas mixture for a new gas called “MyMix1” (50% O<sub>2</sub>, 49.5% Helium, and .5% Neon), stored in user location #236, where the unit ID of the device is “A”:

**A GM MyMix1 236 50.00 11 49.50 7 0.50 10 <ENTER>**

**Gas Name:** Name your mixture using a maximum of 6 characters.

**Gas Mix Number:** COMPOSER™ user mixes have gas numbers between 236 and 255. You can assign any number in this range to your new mixture. If another mixture with the same number exists, it will be overwritten, even if that gas is currently selected on the unit. If you enter a 0 here, the new mix will be assigned the next available number between 236 and 255.

**Percent 1:** The percentage of the first constituent gas. The percentage of each constituent must be between 0.01 and 99.99. Values entered beyond two decimal points will be rounded to the nearest 0.01%.

**Gas Number 1:** The gas number of the first constituent gas.

**Percent 2:** The percentage of the second constituent gas. Values entered beyond two decimal points will be rounded to the nearest 0.01%.

**Gas Number 2:** The gas number of the second constituent gas.

**Additional Gases:** (Optional) The above pattern of [Percent] + [Gas Number] may be repeated for additional constituent gases (up to a total of five).

Upon success, the unit ID (if set) is returned followed by a space. The number of the gas mixture is then returned, followed by the percentages and names of each constituent in the mix. If the gas mix is not successfully created, a “?” is returned, and you must start over.

### Delete a Gas Mixture

To delete a gas mixture, enter:

[Unit ID]GD [Gas Number]: The number of the COMPOSER™ user mixture you wish to delete from the unit

Only COMPOSER™ user mixtures can be deleted with this command.

On success, the unit ID (if set) is returned followed by a space and the number of the gas deleted. If the gas is not successfully deleted, a “?” is returned.

## Collecting Data:

The RS-232 / RS-485 output updates to the screen many times per second. Very short-term events can be captured simply by disconnecting (there are two telephone symbol icons at the top of the HyperTerminal® screen for disconnecting and connecting) immediately after the event in question. The scroll bar can be driven up to the event and all of the data associated with the event can be selected, copied, and pasted into Microsoft® Excel® or other spreadsheet program as described below.

For longer term data, it is useful to capture the data in a text file. With the desired data streaming to the screen, select “Capture Text” from the Transfer Menu. Type in the path and file name you wish to use. Push the start button. When the data collection period is complete, simply select “Capture Text” from the Transfer Menu and select “Stop” from the sub-menu that appears.

Data that is selected and copied, either directly from HyperTerminal® or from a text file can be pasted directly into Excel®. When the data is pasted it will all be in the selected column. Select “Text to Columns...” under the Data menu in Excel® and a Text to Columns Wizard (dialog box) will appear.

Make sure that “Fixed Width” is selected under Original Data Type in the first dialog box and click “Next”. In the second dialog box, set the column widths as desired, but the default is usually acceptable. Click on “Next” again. In the third dialog box, make sure the column data format is set to “General”, and click “Finish”. This separates the data into columns for manipulation and removes symbols such as the plus signs from the numbers. Once the data is in this format, it can be graphed or manipulated as desired. ***For extended term data capture see page 39.***

## Data Format:

The data stream on the screen represents the flow parameters of the main mode in the units shown on the display.

For mass flow controllers, there are six columns of data representing pressure, temperature, volumetric flow, mass flow, set-point, and the selected gas

The first column is absolute pressure (normally in psia), the second column is temperature (normally in °C), the third column is volumetric flow rate (in the units specified at time of order and shown on the display), the fourth column is mass flow (also in the units specified at time of order and shown on the display), the fifth column is the currently selected set-point value, the sixth column designates the currently selected gas. For instance, if the controller was ordered in units of scfm, the display on the controller would read 2.004 scfm and the last two columns of the output below would represent volumetric flow and mass flow in cfm and scfm respectively.

|          |         |           |           |           |     |
|----------|---------|-----------|-----------|-----------|-----|
| +014.70  | +025.00 | +02.004   | +02.004   | 2.004     | Air |
| +014.70  | +025.00 | +02.004   | +02.004   | 2.004     | Air |
| +014.70  | +025.00 | +02.004   | +02.004   | 2.004     | Air |
| +014.70  | +025.00 | +02.004   | +02.004   | 2.004     | Air |
| Pressure | Temp    | Vol. Flow | Mass Flow | Set Point | Gas |

MC-Series Mass Flow Controller Data Format

**Note:** On units with the totalizer function, the sixth column will be the totalizer value, with gas select moving to a seventh column.

## Sending a Simple Script File to HyperTerminal®

It is sometimes desirable to capture data for an extended period of time. Standard streaming mode information is useful for short term events, however, when capturing data for an extended period of time, the amount of data and thus the file size can become too large very quickly. Without any special programming skills, the user can use HyperTerminal® and a text editing program such as Microsoft® Word® to capture text at user defined intervals.

1. Open your text editing program, MS Word for example.
2. Set the cap lock on so that you are typing in capital letters.
3. Beginning at the top of the page, type A<Enter> repeatedly. If you're using MS Word, you can tell how many lines you have by the line count at the bottom of the screen. The number of lines will correspond to the total number of times the flow device will be polled, and thus the total number of lines of data it will produce.

For example:     A  
                  A  
                  A  
                  A  
                  A  
                  A  
                  A

will get a total of six lines of data from the flow meter, but you can enter as many as you like.

The time between each line will be set in HyperTerminal.

4. When you have as many lines as you wish, go to the File menu and select save. In the save dialog box, enter a path and file name as desired and in the "Save as Type" box, select the plain text (.txt) option. It is important that it be saved as a generic text file for HyperTerminal to work with it.
5. Click Save.
6. A file conversion box will appear. In the "End Lines With" drop down box, select CR Only. Everything else can be left as default.
7. Click O.K.
8. You have now created a "script" file to send to HyperTerminal. Close the file and exit the text editing program.
9. Open HyperTerminal and establish communication with your flow device as outlined in the manual.
10. Set the flow device to Polling Mode as described in the manual. Each time you type A<Enter>, the meter should return one line of data to the screen.
11. Go to the File menu in HyperTerminal and select "Properties".
12. Select the "Settings" tab.
13. Click on the "ASCII Setup" button.
14. The "Line Delay" box is defaulted to 0 milliseconds. This is where you will tell the program how often to read a line from the script file you've created. 1000 milliseconds is one second, so if you want a line of data every 30 seconds, you

would enter 30000 into the box. If you want a line every 5 minutes, you would enter 300000 into the box.

15. When you have entered the value you want, click on OK and OK in the Properties dialog box.

16. Go to the Transfer menu and select "Send **Text** File..." (NOT Send File...).

17. Browse and select the text "script" file you created.

18. Click Open.

19. The program will begin "executing" your script file, reading one line at a time with the line delay you specified and the flow device will respond by sending one line of data for each poll it receives, when it receives it.

You can also capture the data to another file as described in the manual under "Collecting Data". You will be simultaneously sending it a script file and capturing the output to a separate file for analysis.

### **Operating Principle**

All M-Series Gas Flow Meters (and MC-Series Gas Flow Controllers) are based on the accurate measurement of volumetric flow. The volumetric flow rate is determined by creating a pressure drop across a unique internal restriction, known as a Laminar Flow Element (LFE), and measuring differential pressure across it. The restriction is designed so that the gas molecules are forced to move in parallel paths along the entire length of the passage; hence laminar (streamline) flow is established for the entire range of operation of the device. Unlike other flow measuring devices, in laminar flow meters the relationship between pressure drop and flow is linear.

**STANDARD GAS DATA TABLES:** Those of you who have older MC-Series products may notice small discrepancies between the gas property tables of your old and new units. The manufacturer has incorporated the latest data sets from NIST (including their REFPROP 9 data where available) in our products' built-in gas property models. Be aware that the calibrators that you may be using may be checking against older data sets such as the widely distributed Air Liquide data. This may generate apparent calibration discrepancies of up to 0.6% of reading on well behaved gases and as much as 3% of reading on some gases such as propane and butane, unless the standard was directly calibrated on the gas in question.

As the older standards are phased out, this difference in readings will cease to be a problem. If you see a difference between the M-Series meter and your in-house standard, in addition to calling Your dealer, call the manufacturer of your standard for clarification as to which data set they used in their calibration. This comparison will in all likelihood resolve the problem.

**GAS SELECT > Standard:**

**MC Controllers** will display: Acetylene, Air, Argon, Butane, Carbon Dioxide, Carbon Monoxide, Ethane, Ethylene (Ethene), Helium, Hydrogen, Iso-Butane, Krypton, Methane, Neon, Nitrogen, Nitrous Oxide, Oxygen, Propane, Sulfur Hexafluoride, Xenon, A-25, A-75, A1025, C-2, C-8, C-10, C-25, C-75, P-5, Star29.

**MCS and MCRS Controllers** add the following: Ammonia, Hydrogen Sulfide, Nitric Oxide, Nitrogen Trifluoride, Propylene, Nitrogen Dioxide to 0.5% in an inert carrier, Refrigerant gases.

| PURE NON-CORROSIVE GASES |            |                     | 25°C               |                     |                             | 0°C                |                     |                             |
|--------------------------|------------|---------------------|--------------------|---------------------|-----------------------------|--------------------|---------------------|-----------------------------|
| Gas Number               | Short Name | Long Name           | Absolute Viscosity | Density 14.696 PSIA | Compressibility 14.696 PSIA | Absolute Viscosity | Density 14.696 PSIA | Compressibility 14.696 PSIA |
| 14                       | C2H2       | Acetylene           | 104.44800          | 1.07200             | 0.9928000                   | 97.374             | 1.1728              | 0.9905                      |
| 0                        | Air        | Air                 | 184.89890          | 1.18402             | 0.9996967                   | 172.574            | 1.2930              | 0.9994                      |
| 1                        | Ar         | Argon               | 226.23990          | 1.63387             | 0.9993656                   | 210.167            | 1.7840              | 0.9991                      |
| 16                       | i-C4H10    | i-Butane            | 74.97846           | 2.44028             | 0.9735331                   | 68.759             | 2.6887              | 0.9645                      |
| 13                       | n-C4H10    | n-Butane            | 74.05358           | 2.44930             | 0.9699493                   | 67.690             | 2.7037              | 0.9591                      |
| 4                        | CO2        | Carbon Dioxide      | 149.31840          | 1.80798             | 0.9949545                   | 137.107            | 1.9768              | 0.9933                      |
| 3                        | CO         | Carbon Monoxide     | 176.49330          | 1.14530             | 0.9996406                   | 165.151            | 1.2505              | 0.9993                      |
| 60                       | D2         | Deuterium           | 126.59836          | 0.16455             | 1.0005970                   | 119.196            | 0.1796              | 1.0006                      |
| 5                        | C2H6       | Ethane              | 93.54117           | 1.23846             | 0.9923987                   | 86.129             | 1.3550              | 0.9901                      |
| 15                       | C2H4       | Ethylene (Ethene)   | 103.18390          | 1.15329             | 0.9942550                   | 94.697             | 1.2611              | 0.9925                      |
| 7                        | He         | Helium              | 198.45610          | 0.16353             | 1.0004720                   | 186.945            | 0.1785              | 1.0005                      |
| 6                        | H2         | Hydrogen            | 89.15355           | 0.08235             | 1.0005940                   | 83.969             | 0.0899              | 1.0006                      |
| 17                       | Kr         | Krypton             | 251.32490          | 3.43229             | 0.9979266                   | 232.193            | 3.7490              | 0.9972                      |
| 2                        | CH4        | Methane             | 110.75950          | 0.65688             | 0.9982472                   | 102.550            | 0.7175              | 0.9976                      |
| 10                       | Ne         | Neon                | 311.12640          | 0.82442             | 1.0004810                   | 293.822            | 0.8999              | 1.0005                      |
| 8                        | N2         | Nitrogen            | 178.04740          | 1.14525             | 0.9998016                   | 166.287            | 1.2504              | 0.9995                      |
| 9                        | N2O        | Nitrous Oxide       | 148.41240          | 1.80888             | 0.9945327                   | 136.310            | 1.9779              | 0.9928                      |
| 11                       | O2         | Oxygen              | 205.50210          | 1.30879             | 0.9993530                   | 191.433            | 1.4290              | 0.9990                      |
| 12                       | C3H8       | Propane             | 81.46309           | 1.83204             | 0.9838054                   | 74.692             | 2.0105              | 0.9785                      |
| 19                       | SF6        | Sulfur Hexafluoride | 153.53200          | 6.03832             | 0.9886681                   | 140.890            | 6.6162              | 0.9849                      |
| 18                       | Xe         | Xenon               | 229.84830          | 5.39502             | 0.9947117                   | 212.157            | 5.8980              | 0.9932                      |

| PURE CORROSIVES* |            |                            | 25°C               |                     |                             | 0°C                |                     |                             |
|------------------|------------|----------------------------|--------------------|---------------------|-----------------------------|--------------------|---------------------|-----------------------------|
| Gas Number       | Short Name | Long Name                  | Absolute Viscosity | Density 14.696 PSIA | Compressibility 14.696 PSIA | Absolute Viscosity | Density 14.696 PSIA | Compressibility 14.696 PSIA |
| 32               | NH3        | Ammonia                    | 100.92580          | 0.70352             | 0.9894555                   | 91.930             | 0.7715              | 0.9848612                   |
| 80               | 1Butene    | Butylene (1-Butene)        | 81.62541           | 2.35906             | 0.9721251                   | 74.354             | 2.6036              | 0.9614456                   |
| 81               | cButene    | Cis-Butene (cis-2-butene)  | 79.96139           | 2.36608             | 0.9692405                   | Liquid             | Liquid              | Liquid                      |
| 82               | iButene    | Iso-Butene                 | 80.84175           | 2.35897             | 0.9721626                   | 73.640             | 2.6038              | 0.9613501                   |
| 83               | tButene    | Trans-Butene               | 80.28018           | 2.36596             | 0.9692902                   | Liquid             | Liquid              | Liquid                      |
| 84               | COS        | Carbonyl Sulfide           | 124.09600          | 2.48322             | 0.9888443                   | 113.127            | 2.7202              | 0.985328                    |
| 33               | Cl2        | Chlorine                   | 134.56600          | 2.93506             | 0.9874470                   | 125.464            | 3.1635              | 0.98407                     |
| 85               | CH3OCH3    | Dimethylether              | 90.99451           | 1.91822             | 0.9816453                   | 82.865             | 2.1090              | 0.9745473                   |
| 34               | H2S        | Hydrogen Sulfide (H2S)     | 123.86890          | 1.40376             | 0.9923556                   | 112.982            | 1.5361              | 0.9898858                   |
| 31               | NF3        | NF3 (Nitrogen Trifluoride) | 175.42500          | 2.91339             | 0.9963859                   | 162.426            | 3.1840              | 0.9951506                   |
| 30               | NO         | NO (Nitric Oxide)          | 190.05950          | 1.22672             | 0.9997970                   | 176.754            | 1.3394              | 0.9995317                   |
| 36               | C3H6       | Propylene (Propylene)      | 85.59895           | 1.74509             | 0.9856064                   | 78.129             | 1.9139              | 0.9809373                   |
| 86               | SiH4       | Silane (SiH4)              | 115.94400          | 1.32003             | 0.9945000                   | 107.053            | 1.4433              | 0.99282                     |
| 35               | SO2        | Sulfur Dioxide             | 127.83100          | 2.66427             | 0.9828407                   | 116.717            | 2.9312              | 0.9750866                   |

\*Pure Corrosive gases are only available on S-Series instruments that are compatible with these gases. Gas numbers 33 and 35 are not available on controllers

| REFRIGERANTS |            |                                    | 25°C               |                     |                             |                    | 0°C                 |                             |                    |                     |                             |
|--------------|------------|------------------------------------|--------------------|---------------------|-----------------------------|--------------------|---------------------|-----------------------------|--------------------|---------------------|-----------------------------|
| Gas Number   | Short Name | Long Name                          | Absolute Viscosity | Density 14.696 PSIA | Compressibility 14.696 PSIA | Absolute Viscosity | Density 14.696 PSIA | Compressibility 14.696 PSIA | Absolute Viscosity | Density 14.696 PSIA | Compressibility 14.696 PSIA |
| 100          | R-11       | Trichlorofluoromethane             | 101.60480          | 5.82358             | 0.9641448                   | Liquid             | Liquid              | Liquid                      | Liquid             | Liquid              | Liquid                      |
| 101          | R-115      | Chloropentafluoroethane            | 125.14780          | 6.43293             | 0.9814628                   | 114.891            | 7.0666              | 0.9752287                   | 114.891            | 7.0666              | 0.9752287                   |
| 102          | R-116      | Hexafluoroethane                   | 137.81730          | 5.70097             | 0.9895011                   | 126.635            | 6.2458              | 0.9858448                   | 126.635            | 6.2458              | 0.9858448                   |
| 103          | R-124      | Chlorotetrafluoroethane            | 115.93110          | 5.72821             | 0.9738286                   | 105.808            | 6.3175              | 0.963807                    | 105.808            | 6.3175              | 0.963807                    |
| 104          | R-125      | Pentafluoroethane                  | 129.61740          | 4.98169             | 0.9847599                   | 118.793            | 5.4689              | 0.979137                    | 118.793            | 5.4689              | 0.979137                    |
| 105          | R-134A     | Tetrafluoroethane                  | 118.18820          | 4.25784             | 0.9794810                   | 108.311            | 4.6863              | 0.9713825                   | 108.311            | 4.6863              | 0.9713825                   |
| 106          | R-14       | Tetrafluoromethane                 | 172.44680          | 3.61084             | 0.9962553                   | 159.688            | 3.9467              | 0.9948964                   | 159.688            | 3.9467              | 0.9948964                   |
| 107          | R-142b     | Chlorodifluoroethane               | 104.20190          | 4.21632             | 0.9742264                   | 95.092             | 4.6509              | 0.9640371                   | 95.092             | 4.6509              | 0.9640371                   |
| 108          | R-143a     | Trifluoroethane                    | 110.86600          | 3.49451             | 0.9830011                   | 101.344            | 3.8394              | 0.9765755                   | 101.344            | 3.8394              | 0.9765755                   |
| 109          | R-152a     | Difluoroethane                     | 100.81320          | 2.75903             | 0.9785245                   | 91.952             | 3.0377              | 0.9701025                   | 91.952             | 3.0377              | 0.9701025                   |
| 110          | R-22       | Difluoromonochloromethane          | 126.30390          | 3.58679             | 0.9853641                   | 115.325            | 3.9360              | 0.9801128                   | 115.325            | 3.9360              | 0.9801128                   |
| 111          | R-23       | Trifluoromethane                   | 149.13160          | 2.88404             | 0.9922734                   | 136.997            | 3.1568              | 0.9895204                   | 136.997            | 3.1568              | 0.9895204                   |
| 112          | R-32       | Difluoromethane                    | 126.13140          | 2.15314             | 0.9875960                   | 115.303            | 2.3619              | 0.9827161                   | 115.303            | 2.3619              | 0.9827161                   |
| 113          | RC-318     | Octafluorocyclobutane              | 115.04690          | 8.42917             | 0.9700156                   | 104.785            | 9.3017              | 0.9594738                   | 104.785            | 9.3017              | 0.9594738                   |
| 114          | R-404A     | 44% R-125 / 4% R-134A / 52% R-143A | 120.30982          | 4.18002             | 0.9836342                   | 111.584            | 4.5932              | 0.9770889                   | 111.584            | 4.5932              | 0.9770889                   |
| 115          | R-407C     | 23% R-32 / 25% R-125 / 52% R-134A  | 123.55369          | 3.95268             | 0.9826672                   | 112.698            | 4.3427              | 0.9762849                   | 112.698            | 4.3427              | 0.9762849                   |
| 116          | R-410A     | 50% R-32 / 50% R-125               | 130.24384          | 3.56538             | 0.9861780                   | 122.417            | 3.9118              | 0.9811061                   | 122.417            | 3.9118              | 0.9811061                   |
| 117          | R-507A     | 50% R-125 / 50% R-143A             | 121.18202          | 4.23876             | 0.9838805                   | 112.445            | 4.6573              | 0.9774207                   | 112.445            | 4.6573              | 0.9774207                   |

\*Refrigerant gases are only available on S-Series instruments that are compatible with these gases.

| WELDING GASES |        | Short Name                         | Long Name | 25°C               |                     |                             | 0°C                |                     |                             |
|---------------|--------|------------------------------------|-----------|--------------------|---------------------|-----------------------------|--------------------|---------------------|-----------------------------|
|               |        |                                    |           | Absolute Viscosity | Density 14.696 PSIA | Compressibility 14.696 PSIA | Absolute Viscosity | Density 14.696 PSIA | Compressibility 14.696 PSIA |
| <b>23</b>     | C-2    | 2% CO2 / 98% Ar                    | 224.71480 | 1.63727            | 0.9993165           | 208.673                     | 1.7877             | 0.998993            |                             |
| <b>22</b>     | C-8    | 8% CO2 / 92% Ar                    | 220.13520 | 1.64749            | 0.9991624           | 204.199                     | 1.7989             | 0.9987964           |                             |
| <b>21</b>     | C-10   | 10% CO2 / 90% Ar                   | 218.60260 | 1.65091            | 0.9991086           | 202.706                     | 1.8027             | 0.9987278           |                             |
| <b>140</b>    | C-15   | 15% CO2 / 85% Ar                   | 214.74960 | 1.65945            | 0.9989687           | 198.960                     | 1.8121             | 0.9985493           |                             |
| <b>141</b>    | C-20   | 20% CO2 / 80% Ar                   | 210.86960 | 1.66800            | 0.9988210           | 195.198                     | 1.8215             | 0.9983605           |                             |
| <b>20</b>     | C-25   | 25% CO2 / 75% Ar                   | 206.97630 | 1.67658            | 0.9986652           | 191.436                     | 1.8309             | 0.9981609           |                             |
| <b>142</b>    | C-50   | 50% CO2 / 50% Ar                   | 187.53160 | 1.71972            | 0.9977484           | 172.843                     | 1.8786             | 0.9969777           |                             |
| <b>24</b>     | C-75   | 75% CO2 / 25% Ar                   | 168.22500 | 1.76344            | 0.9965484           | 154.670                     | 1.9271             | 0.995401            |                             |
| <b>25</b>     | He-25  | 25% He / 75% Ar                    | 231.60563 | 1.26598            | 0.9996422           | 216.008                     | 1.3814             | 0.9999341           |                             |
| <b>143</b>    | He-50  | 50% He / 50% Ar                    | 236.15149 | 0.89829            | 0.9999188           | 220.464                     | 0.9800             | 1.00039             |                             |
| <b>26</b>     | He-75  | 75% He / 25% Ar                    | 234.68601 | 0.53081            | 1.0001954           | 216.937                     | 0.5792             | 1.000571            |                             |
| <b>144</b>    | He-90  | 90% He / 10% Ar                    | 222.14566 | 0.31041            | 1.0003614           | 205.813                     | 0.3388             | 1.00057             |                             |
| <b>27</b>     | A1025  | 90% He / 7.5% Ar / 2.5% CO2        | 214.97608 | 0.31460            | 1.0002511           | 201.175                     | 0.3433             | 1.000556            |                             |
| <b>28</b>     | Star29 | Stargon C5 90% Ar / 8% CO2 / 2% O2 | 219.79340 | 1.64099            | 0.9991638           | 203.890                     | 1.7918             | 0.998798            |                             |

| BIOREACTOR GASES |            |                   | 25°C               |                     |                             |                    | 0°C                 |                             |  |  |
|------------------|------------|-------------------|--------------------|---------------------|-----------------------------|--------------------|---------------------|-----------------------------|--|--|
| Gas Number       | Short Name | Long Name         | Absolute Viscosity | Density 14.696 PSIA | Compressibility 14.696 PSIA | Absolute Viscosity | Density 14.696 PSIA | Compressibility 14.696 PSIA |  |  |
| 145              | Bio-5M     | 5% CH4 / 95% CO2  | 148.46635          | 1.75026             | 0.9951191                   | 136.268            | 1.9134              | 0.9935816                   |  |  |
| 146              | Bio-10M    | 10% CH4 / 90% CO2 | 147.54809          | 1.69254             | 0.9952838                   | 135.383            | 1.8500              | 0.993893                    |  |  |
| 147              | Bio-15M    | 15% CH4 / 85% CO2 | 146.55859          | 1.63484             | 0.9954484                   | 134.447            | 1.7867              | 0.9941932                   |  |  |
| 148              | Bio-20M    | 20% CH4 / 80% CO2 | 145.49238          | 1.57716             | 0.9956130                   | 133.457            | 1.7235              | 0.994482                    |  |  |
| 149              | Bio-25M    | 25% CH4 / 75% CO2 | 144.34349          | 1.51950             | 0.9957777                   | 132.407            | 1.6603              | 0.9947594                   |  |  |
| 150              | Bio-30M    | 30% CH4 / 70% CO2 | 143.10541          | 1.46186             | 0.9959423                   | 131.290            | 1.5971              | 0.9950255                   |  |  |
| 151              | Bio-35M    | 35% CH4 / 65% CO2 | 141.77101          | 1.40424             | 0.9961069                   | 130.102            | 1.5340              | 0.9952803                   |  |  |
| 152              | Bio-40M    | 40% CH4 / 60% CO2 | 140.33250          | 1.34664             | 0.9962716                   | 128.834            | 1.4710              | 0.9955239                   |  |  |
| 153              | Bio-45M    | 45% CH4 / 55% CO2 | 138.78134          | 1.28905             | 0.9964362                   | 127.478            | 1.4080              | 0.9957564                   |  |  |
| 154              | Bio-50M    | 50% CH4 / 50% CO2 | 137.10815          | 1.23149             | 0.9966009                   | 126.025            | 1.3450              | 0.9959779                   |  |  |
| 155              | Bio-55M    | 55% CH4 / 45% CO2 | 135.30261          | 1.17394             | 0.9967655                   | 124.462            | 1.2821              | 0.9961886                   |  |  |
| 156              | Bio-60M    | 60% CH4 / 40% CO2 | 133.35338          | 1.11642             | 0.9969301                   | 122.779            | 1.2193              | 0.9963885                   |  |  |
| 157              | Bio-65M    | 65% CH4 / 35% CO2 | 131.24791          | 1.05891             | 0.9970948                   | 120.959            | 1.1564              | 0.9965779                   |  |  |
| 158              | Bio-70M    | 70% CH4 / 30% CO2 | 128.97238          | 1.00142             | 0.9972594                   | 118.987            | 1.0936              | 0.9967567                   |  |  |
| 159              | Bio-75M    | 75% CH4 / 25% CO2 | 126.51146          | 0.94395             | 0.9974240                   | 116.842            | 1.0309              | 0.9969251                   |  |  |
| 160              | Bio-80M    | 80% CH4 / 20% CO2 | 123.84817          | 0.88650             | 0.9975887                   | 114.501            | 0.9681              | 0.9970832                   |  |  |
| 161              | Bio-85M    | 85% CH4 / 15% CO2 | 120.96360          | 0.82907             | 0.9977533                   | 111.938            | 0.9054              | 0.9972309                   |  |  |
| 162              | Bio-90M    | 90% CH4 / 10% CO2 | 117.83674          | 0.77166             | 0.9979179                   | 109.119            | 0.8427              | 0.9973684                   |  |  |
| 163              | Bio-95M    | 95% CH4 / 5% CO2  | 114.44413          | 0.71426             | 0.9980826                   | 106.005            | 0.7801              | 0.9974957                   |  |  |

| BREATHING GASES |            |   | 25°C               |                     |                             | 0°C                |                     |                             |
|-----------------|------------|---|--------------------|---------------------|-----------------------------|--------------------|---------------------|-----------------------------|
| Gas Number      | Short Name | Long Name   | Absolute Viscosity | Density 14.696 PSIA | Compressibility 14.696 PSIA | Absolute Viscosity | Density 14.696 PSIA | Compressibility 14.696 PSIA |
| 164             | EAN-32     | 32% O <sub>2</sub> / 68% N <sub>2</sub>   | 186.86315          | 1.19757             | 0.9996580                   | 174.925            | 1.3075              | 0.9993715                   |
| 165             | EAN        | 36% O <sub>2</sub> / 64% N <sub>2</sub>   | 187.96313          | 1.20411             | 0.9996401                   | 175.963            | 1.3147              | 0.9993508                   |
| 166             | EAN-40     | 40% O <sub>2</sub> / 60% N <sub>2</sub>   | 189.06268          | 1.21065             | 0.9996222                   | 176.993            | 1.3218              | 0.9993302                   |
| 167             | HeOx-20    | 20% O <sub>2</sub> / 80% He   | 217.88794          | 0.39237             | 1.0002482                   | 204.175            | 0.4281              | 1.000593                    |
| 168             | HeOx-21    | 21% O <sub>2</sub> / 79% He   | 218.15984          | 0.40382             | 1.0002370                   | 204.395            | 0.4406              | 1.000591                    |
| 169             | HeOx-30    | 30% O <sub>2</sub> / 70% He   | 219.24536          | 0.50683             | 1.0001363                   | 205.140            | 0.5530              | 1.000565                    |
| 170             | HeOx-40    | 40% O <sub>2</sub> / 60% He   | 218.59913          | 0.62132             | 1.0000244                   | 204.307            | 0.6779              | 1.000502                    |
| 171             | HeOx-50    | 50% O <sub>2</sub> / 50% He   | 216.95310          | 0.73583             | 0.9999125                   | 202.592            | 0.8028              | 1.000401                    |
| 172             | HeOx-60    | 60% O <sub>2</sub> / 40% He   | 214.82626          | 0.85037             | 0.9998006                   | 200.467            | 0.9278              | 1.000257                    |
| 173             | HeOx-80    | 80% O <sub>2</sub> / 20% He   | 210.11726          | 1.07952             | 0.9995768                   | 195.872            | 1.1781              | 0.9998019                   |
| 174             | HeOx-99    | 99% O <sub>2</sub> / 1% He  | 205.72469          | 1.29731             | 0.9993642                   | 191.646            | 1.4165              | 0.9990796                   |
| 175             | EA-40      | Enriched Air-40% O <sub>2</sub>   | 189.42518          | 1.21429             | 0.9996177                   | 177.396            | 1.3258              | 0.9993261                   |
| 176             | EA-60      | Enriched Air-60% O <sub>2</sub>   | 194.79159          | 1.24578             | 0.9995295                   | 182.261            | 1.3602              | 0.9992266                   |
| 177             | EA-80      | Enriched Air-80% O <sub>2</sub>   | 200.15060          | 1.27727             | 0.9994412                   | 186.937            | 1.3946              | 0.9991288                   |
| 178             | Metabol    | Metabolic Exhalant (16% O <sub>2</sub> / 78.04% N <sub>2</sub> / 5% CO <sub>2</sub> / 0.96% Ar) | 180.95936          | 1.20909             | 0.9994833                   | 170.051            | 1.3200              | 0.9992587                   |

| FUEL GASES |            |   | 25°C               |                     |                             |                    | 0°C                 |                             |  |
|------------|------------|---|--------------------|---------------------|-----------------------------|--------------------|---------------------|-----------------------------|--|
| Gas Number | Short Name | Long Name   | Absolute Viscosity | Density 14.696 PSIA | Compressibility 14.696 PSIA | Absolute Viscosity | Density 14.696 PSIA | Compressibility 14.696 PSIA |  |
| 185        | Syn Gas-1  | 40% H2 + 29% CO + 20% CO2 + 11% CH4                                 | 155.64744          | 0.79774             | 0.9989315                   | 144.565            | 0.8704              | 0.9992763                   |  |
| 186        | Syn Gas-2  | 64% H2 + 28% CO + 1% CO2 + 7% CH4                                   | 151.98915          | 0.43715             | 1.0001064                   | 142.249            | 0.4771              | 1.000263                    |  |
| 187        | Syn Gas-3  | 70% H2 + 4% CO + 25% CO2 + 1% CH4                                   | 147.33686          | 0.56024             | 0.9991225                   | 136.493            | 0.6111              | 0.9997559                   |  |
| 188        | Syn Gas-4  | 88% H2 + 14% CO + 3% CH4  | 133.63682          | 0.24825             | 1.0003901                   | 125.388            | 0.2709              | 1.000509                    |  |
| 189        | Nat Gas-1  | 93% CH4 / 3% C2H6 / 1% C3H8 / 2% N2 / 1% CO2                        | 111.77027          | 0.70709             | 0.9979255                   | 103.189            | 0.7722              | 0.9973965                   |  |
| 190        | Nat Gas-2  | 95% CH4 / 3% C2H6 / 1% N2 / 1% CO2                                  | 111.55570          | 0.69061             | 0.9980544                   | 103.027            | 0.7543              | 0.9974642                   |  |
| 191        | Nat Gas-3  | 95.2% CH4 / 2.5% C2H6 / 0.2% C3H8 / 0.1% C4H10 / 1.3% N2 / 0.7% CO2 | 111.49608          | 0.68980             | 0.9980410                   | 102.980            | 0.7534              | 0.9974725                   |  |
| 192        | Coal Gas   | 50% H2 / 35% CH4 / 10% CO / 5% C2H4                                 | 123.68517          | 0.44281             | 0.9993603                   | 115.045            | 0.6589              | 0.996387                    |  |
| 193        | Endo       | 75% H2 + 25% N2   | 141.72100          | 0.34787             | 1.0005210                   | 133.088            | 0.3797              | 1.000511                    |  |
| 194        | HHO        | 66.67% H2 / 33.33% O2   | 180.46190          | 0.49078             | 1.0001804                   | 168.664            | 0.5356              | 1.000396                    |  |
| 195        | HD-5       | LPG 96.1% C3H8 / 1.5% C2H6 / 0.4% C3H6 / 1.9% n-C4H10               | 81.45829           | 1.83428             | 0.9836781                   | 74.933             | 2.0128              | 0.9784565                   |  |
| 196        | HD-10      | LPG 85% C3H8 / 10% C3H6 / 5% n-C4H10                                | 81.41997           | 1.85378             | 0.9832927                   | 74.934             | 2.0343              | 0.9780499                   |  |

| LASER GASES |            |                                  | 25°C               |                     |                             |                    | 0°C                 |                             |  |
|-------------|------------|----------------------------------|--------------------|---------------------|-----------------------------|--------------------|---------------------|-----------------------------|--|
| Gas Number  | Short Name | Long Name                        | Absolute Viscosity | Density 14.696 PSIA | Compressibility 14.696 PSIA | Absolute Viscosity | Density 14.696 PSIA | Compressibility 14.696 PSIA |  |
| 179         | LG-4.5     | 4.5% CO2 / 13.5% N2 / 82% He     | 199.24300          | 0.36963             | 1.0001332                   | 187.438            | 0.4033              | 1.000551                    |  |
| 180         | LG-6       | 6% CO2 / 14% N2 / 80% He         | 197.87765          | 0.39910             | 1.0000471                   | 186.670            | 0.4354              | 1.00053                     |  |
| 181         | LG-7       | 7% CO2 / 14% N2 / 79% He         | 197.00519          | 0.41548             | 0.9999919                   | 186.204            | 0.4533              | 1.000514                    |  |
| 182         | LG-9       | 9% CO2 / 15% N2 / 76% He         | 195.06655          | 0.45805             | 0.9998749                   | 184.835            | 0.4997              | 1.000478                    |  |
| 183         | HeNe-9     | 9% Ne / 91% He                   | 224.68017          | 0.22301             | 1.0004728                   | 211.756            | 0.2276              | 1.000516                    |  |
| 184         | LG-9.4     | 9.4% CO2 / 19.25% N2 / 71.35% He | 193.78311          | 0.50633             | 0.9998243                   | 183.261            | 0.5523              | 1.000458                    |  |

| <b>O2 CONCENTRATOR GASES</b> |                   |                        |                           | <b>25°C</b>                |                                    |                           | <b>0°C</b>                 |                                    |  |
|------------------------------|-------------------|------------------------|---------------------------|----------------------------|------------------------------------|---------------------------|----------------------------|------------------------------------|--|
| <b>Gas Number</b>            | <b>Short Name</b> | <b>Long Name</b>       | <b>Absolute Viscosity</b> | <b>Density 14.696 PSIA</b> | <b>Compressibility 14.696 PSIA</b> | <b>Absolute Viscosity</b> | <b>Density 14.696 PSIA</b> | <b>Compressibility 14.696 PSIA</b> |  |
| 197                          | OCG-89            | 89% O2 / 7% N2 / 4% Ar | 204.53313                 | 1.31033                    | 0.9993849                          | 190.897                   | 1.4307                     | 0.9990695                          |  |
| 198                          | OCG-93            | 93% O2 / 3% N2 / 4% Ar | 205.62114                 | 1.31687                    | 0.9993670                          | 191.795                   | 1.4379                     | 0.9990499                          |  |
| 199                          | OCG-95            | 95% O2 / 1% N2 / 4% Ar | 206.16497                 | 1.32014                    | 0.9993580                          | 192.241                   | 1.4414                     | 0.99904                            |  |

| <b>STACK GASES</b> |                   |  |                           | <b>25°C</b>                |                                    |                           | <b>0°C</b>                 |                                    |  |
|--------------------|-------------------|--|---------------------------|----------------------------|------------------------------------|---------------------------|----------------------------|------------------------------------|--|
| <b>Gas Number</b>  | <b>Short Name</b> | <b>Long Name</b>                       | <b>Absolute Viscosity</b> | <b>Density 14.696 PSIA</b> | <b>Compressibility 14.696 PSIA</b> | <b>Absolute Viscosity</b> | <b>Density 14.696 PSIA</b> | <b>Compressibility 14.696 PSIA</b> |  |
| 200                | FG-1              | 2.5% O2 / 10.8% CO2 / 85.7% N2 / 1% Ar | 175.22575                 | 1.22550                    | 0.9992625                          | 165.222                   | 1.3379                     | 0.9990842                          |  |
| 201                | FG-2              | 2.9% O2 / 14% CO2 / 82.1% N2 / 1% Ar   | 174.18002                 | 1.24729                    | 0.9991056                          | 164.501                   | 1.3617                     | 0.9989417                          |  |
| 202                | FG-3              | 3.7% O2 / 15% CO2 / 80.3% N2 / 1% Ar   | 174.02840                 | 1.25520                    | 0.9990536                          | 164.426                   | 1.3703                     | 0.9988933                          |  |
| 203                | FG-4              | 7% O2 / 12% CO2 / 80% N2 / 1% Ar       | 175.95200                 | 1.24078                    | 0.9991842                          | 166.012                   | 1.3546                     | 0.9990116                          |  |
| 204                | FG-5              | 10% O2 / 9.5% CO2 / 79.5% N2 / 1% Ar   | 177.65729                 | 1.22918                    | 0.9992919                          | 167.401                   | 1.3419                     | 0.9991044                          |  |
| 205                | FG-6              | 13% O2 / 7% CO2 / 79% N2 / 1% Ar       | 179.39914                 | 1.21759                    | 0.9993996                          | 168.799                   | 1.3293                     | 0.9991932                          |  |

| <b>CHROMATOGRAPHY GASES</b> |                   |                  |                           | <b>25°C</b>                |                                    |                           | <b>0°C</b>                 |                                    |  |
|-----------------------------|-------------------|------------------|---------------------------|----------------------------|------------------------------------|---------------------------|----------------------------|------------------------------------|--|
| <b>Gas Number</b>           | <b>Short Name</b> | <b>Long Name</b> | <b>Absolute Viscosity</b> | <b>Density 14.696 PSIA</b> | <b>Compressibility 14.696 PSIA</b> | <b>Absolute Viscosity</b> | <b>Density 14.696 PSIA</b> | <b>Compressibility 14.696 PSIA</b> |  |
| 29                          | P-5               | 5% CH4 / 95% Ar  | 223.91060                 | 1.58505                    | 0.9993265                          | 207.988                   | 1.7307                     | 0.9990036                          |  |
| 206                         | P-10              | 10% CH4 90% Ar   | 221.41810                 | 1.53622                    | 0.9992857                          | 205.657                   | 1.6774                     | 0.99895                            |  |

**Supported Units:** This device supports many different units. You may select the desired units (see page 28). Note that only units appropriate to this device are available for selection.

**Pressure Units**

| Absolute | Gauge   | Differential | Notes  |
|----------|---|--------------|--|
| PaA      | PaG   | PaD          | pascal   |
| hPaA     | hPaG  | hPaD         | hectopascal                                    |
| kPaA     | kPaG  | kPaD         | kilopascal                                     |
| MPaA     | MPaG  | MPaD         | megapascal                                     |
| mbarA    | mbarG   | mbarD        | millibar                                       |
| barA     | barG  | barD         | bar  |
| g/cm2A   | g/cm2G  | g/cm2D       | gram force per square centimeter               |
| kg/cmA   | kg/cmG  | kg/cmD       | kilogram force per square centimeter           |
| PSIA     | PSIG  | PSID         | pound force per square inch                    |
| PSFA     | PSFG  | PSFD         | pound force per square foot                    |
| mTorrA   | mTorrG  | mTorrD       | millitorr                                      |
| torrA    | torrG   | torrD        | torr   |
| mmHgA    | mmHgG   | mmHgD        | millimeter of mercury at 0 C                   |
| inHgA    | inHgG   | inHgD        | inch of mercury at 0 C                         |
| mmH2OA   | mmH2OG  | mmH2OD       | millimeter of water at 4 C (NIST conventional) |
| mmH2OA   | mmH2OG  | mmH2OD       | millimeter of water at 60 C                    |
| cmH2OA   | cmH2OG  | cmH2OD       | centimeter of water at 4 C (NIST conventional) |
| cmH2OA   | cmH2OG  | cmH2OD       | centimeter of water at 60 C                    |
| inH2OA   | inH2OG  | inH2OD       | inch of water at 4 C (NIST conventional)       |
| inH2OA   | inH2OG  | inH2OD       | inch of water at 60 C                          |
| atm      |   |              | atmosphere                                     |
| m asl    |   |              | meter above sea level (only in /ALT builds)    |
| ft asl   |   |              | foot above sea level (only in /ALT builds)     |
| V        | volt; no conversions are performed to or from other units |              |  |
| count    | count   | count        | setpoint count, 0 – 64000                      |
| %        | %   | %            | percent of full scale                          |

**Flow Units**

| Volumetric | Standard | Normal | Notes                       |
|------------|----------|--------|-----------------------------|
| uL/m       | SuL/m    | NuL/m  | microliter per minute       |
| mL/s       | SmL/s    | NmL/s  | milliliter per second       |
| mL/m       | SmL/m    | NmL/m  | milliliter per minute       |
| mL/h       | SmL/h    | NmL/h  | milliliter per hour         |
| L/s        | SL/s     | NL/s   | liter per second            |
| LPM        | SLPM     | NLPM   | liter per minute            |
| L/h        | SL/h     | NL/h   | liter per hour              |
| US GPM     |          |        | US gallon per minute        |
| US GPH     |          |        | US gallon per hour          |
| CCS        | SCCS     | NCCS   | cubic centimeter per second |
| CCM        | SCCM     | NCCM   | cubic centimeter per minute |
| cm3/h      | Scm3/h   | Ncm3/h | cubic centimeter per hour   |
| m3/m       | Sm3/m    | Nm3/m  | cubic meter per minute      |
| m3/h       | Sm3/h    | Nm3/h  | cubic meter per hour        |
| m3/d       | Sm3/d    | Nm3/d  | cubic meter per day         |
| in3/m      | Sin3/m   |        | cubic inch per minute       |
| CFM        | SCFM     |        | cubic foot per minute       |
| CFH        | SCFH     |        | cubic foot per hour         |
|            | kSCFM    |        | 1000 cubic feet per minute  |
| count      | count    | count  | setpoint count, 0 – 64000   |
| %          | %        | %      | percent of full scale       |

### True Mass Flow Units

| Label | Notes                |
|-------|----------------------|
| mg/s  | milligram per second |
| mg/m  | milligram per minute |
| g/s   | gram per second      |
| g/m   | gram per minute      |
| g/h   | gram per hour        |
| kg/m  | kilogram per minute  |
| kg/h  | kilogram per hour    |
| oz/s  | ounce per second     |
| oz/m  | ounce per minute     |
| lb/m  | pound per minute     |
| lb/h  | pound per hour       |

These can be used for mass flow on gas devices. These can also be used for volumetric flow on liquid devices calibrated in one of these units (liquid density is not yet supported).

### Totalizer Units

| Volumetric | Standard  | Normal | Notes            |
|------------|---|--------|------------------|
| uL         | SuL   | NuL    | microliter       |
| mL         | SmL   | NmL    | milliliter       |
| L          | SL  | NL     | liter            |
| US GAL     |   |        | US gallon        |
| cm3        | Scm3  | Ncm3   | cubic centimeter |
| m3         | Sm3   | Nm3    | cubic meter      |
| in3        | Sin3  |        | cubic inch       |
| ft3        | Sft3  |        | cubic foot       |
|            | kSft3   |        | 1000 cubic feet  |
| uP         | micropoise, a measure of viscosity; no conversions are performed to or from other units |        |                  |

### Total Mass Units

| Label | Notes     |
|-------|-----------|
| mg    | milligram |
| g     | gram      |
| kg    | kilogram  |
| oz    | ounce     |
| lb    | pound     |

These can be used for totalized mass on gas devices. These can also be used for totalized volume on liquid devices calibrated in one of these units (liquid density is not yet supported).

### Temperature Units

| Label | Notes             |
|-------|-------------------|
| °C    | degree Celsius    |
| °F    | degree Fahrenheit |
| K     | Kelvin            |
| °R    | degree Rankine    |

### Time Units

| Label | Notes                                    |
|-------|--|
| h:m:s | Displayed value is hours:minutes:seconds |
| ms    | millisecond                              |
| s     | second                                   |
| m     | minute                                   |
| hour  | hour                                     |
| day   | day                                      |

### Valve Drive Units

| Label | Notes                       |
|-------|-----------------------------|
| count | +/- 65536 at full drive     |
| %     | Percent of full scale drive |

## TROUBLESHOOTING

### ***Display does not come on or is weak.***

Check power and ground connections. Please reference the technical specifications (pages 58 - 78) to assure you have the proper power for your model.

### ***Flow reading is approximately fixed either near zero or near full scale regardless of actual line flow.***

Differential pressure sensor may be damaged. A common cause of this problem is instantaneous application of high-pressure gas as from a snap acting solenoid valve upstream of the meter. If you suspect that your pressure sensor is damaged please discontinue use of the controller and contact Your dealer.

### ***Displayed mass flow, volumetric flow, pressure or temperature is flashing and message MOV, VOV, POV or TOV is displayed:***

Our flow meters and controllers display an error message (MOV = mass overrange, VOV = volumetric overrange, POV = pressure overrange, TOV = temperature overrange) when a measured parameter exceeds the range of the sensors in the device. When any item flashes on the display, neither the flashing parameter nor the mass flow measurement is accurate. Reducing the value of the flashing parameter to within specified limits will return the unit to normal operation and accuracy. If the unit does not return to normal contact Your dealer.

### ***After installation, there is no flow.***

MC controllers incorporate normally closed valves and require a set-point to operate. Check that your set-point signal is present and supplied to the correct pin and that the correct set-point source is selected under the SETPT SOURCE list in the control set up display. Also check that the unit is properly grounded.

### ***The flow lags below the set-point.***

Be sure there is enough pressure available to make the desired flow rate. If either the set-point signal line and/or the output signal line is relatively long, it may be necessary to provide heavier wires (especially ground wiring) to negate voltage drops due to line wire length. An inappropriate PID tuning can also cause this symptom if the D term is too large relative to the P term. See pages 20 and 21 for more information on PID tuning.

### ***Controller is slow to react to a set-point change or imparts an oscillation to the flow.***

An inappropriate PID tuning can cause these symptoms. Use at conditions considerably different than those at which the device was originally set up can necessitate a re-tuning of the PID loop. See pages 20 and 21 for more information on PID tuning.

### ***The output signal is lower than the reading at the display.***

This can occur if the output signal is measured some distance from the meter, as voltage drops in the wires increase with distance. Using heavier gauge wires,

especially in the ground wire, can reduce this effect.

***Meter does not agree with another meter I have in line.***

Volumetric meters are affected by pressure drops. Volumetric flow meters should not be compared to mass flow meters. Mass flow meters can be compared against one another provided there are no leaks between the two meters and they are set to the same standard temperature and pressure. Both meters must also be calibrated (or set) for the gas being measured. M Series mass flow meters are normally set to Standard Temperature and Pressure conditions of 25 ° C and 14.696 psia. Note: it is possible to special order meters with a customer specified set of standard conditions. The calibration sheet provided with each meter lists its standard conditions.

When performing this comparison it is best to use the smallest transition possible between the two devices. Using small transitions will minimize lag and dead volume.

***RS-232 / RS-485 Serial Communications is not responding.***

Check that your meter is powered and connected properly. Be sure that the port on the computer to which the meter is connected is active. Confirm that the port settings are correct per the RS-232 instructions in this manual (Check the RS-232 / RS-485 communications select screen for current meter readings). Close Hyperterminal® and reopen it. Reboot your PC. See pages 10, 11 and 31 for more information on RS-232 / RS-485 signals and communications.

***Slower response than specified.***

MC-Series Controllers feature a programmable Geometric Running Average (GRA). Depending on the full scale range of the meter, it may have the GRA set to enhance the stability/readability of the display, which would result in slower perceived response time. Please see “Pressure Averaging” and “Flow Averaging” on page 26.

***Jumps to zero at low flow.***

MC-Series Controllers feature a programmable zero deadband. The factory setting is usually 0.5% of full scale. This can be adjusted between NONE and 3.2% of full scale. See page 26.

***Discrepancies between old and new units.***

Please see “Standard Gas Data Tables” explanation on page 40.

### **Maintenance and Recalibration**

**General:** MC-Series Flow Controllers require minimal maintenance. They have no moving parts. The single most important thing that affects the life and accuracy of these devices is the quality of the gas being measured. The controller is designed to measure CLEAN, DRY, NON-CORROSIVE gases.

Moisture, oil and other contaminants can affect the laminar flow elements. We recommend the use of in-line sintered filters to prevent large particulates from entering the measurement head of the instrument. Suggested maximum particulate sizes are as follows:

- 5 microns for units with FS flow ranges of 0-1 sccm or less.

- 20 microns for units with FS flow ranges between 0-2 sccm and 0-1 slpm.

- 50 microns for units with FS flow ranges of 0-1 slpm or more.

**Recalibration:** The recommended period for recalibration is once every year. A label located on the back of the controller lists the most recent calibration date. The controller should be returned to the factory for recalibration within one year from the listed date. Before calling to schedule a recalibration, please note the serial number on the back of the instrument. The Serial Number, Model Number, and Date of Manufacture are also available on the Model Info display (page 29).

**Cleaning:** MC-Series Flow Controllers require no periodic cleaning. If necessary, the outside of the controller can be cleaned with a soft dry cloth. Avoid excess moisture or solvents.

For repair, recalibration or recycling of this product contact Your dealer.

## Option: Totalizing Mode - Controllers

Controllers can be purchased with the Totalizing Mode option. This option adds an additional mode screen that displays the total flow (normally in the units of the main flow screen) that has passed through the device since the last time the totalizer was cleared. The Totalizing Mode screen is accessed by pushing the **TOTAL/TIMER** button on the **MAIN** display.

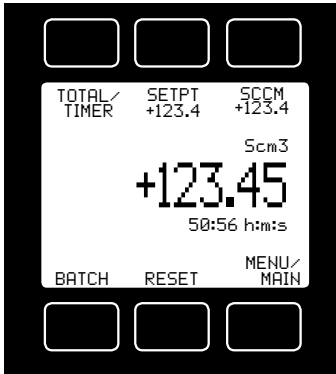

**TOTAL/TIMER:** Pushing the TOTAL/TIMER button will cycle the large numbers on the display between total mass and time elapsed.

**Rollover** – The customer can also specify at the time of order what the totalizer is to do when the maximum count is reached. The following options may be specified:

**No Rollover** – When the counter reaches the maximum count it stops counting until the counter is cleared.

**Rollover** – When the counter reaches the maximum count it automatically rolls over to zero and continues counting until the counter is cleared.

**Rollover with Notification** – When the counter reaches the maximum count it automatically rolls over to zero, displays an overflow error, and continues counting until the counter is cleared.

**TOTAL MASS:** The counter can have as many as seven digits. At the time of order, the customer must specify the range. This directly affects the maximum count. For instance, if a range of 1/100ths of a liter is specified on a meter which is totalizing in liters, the maximum count would be 99999.99 liters. If the same unit were specified with a 1 liter range, the maximum count would be 9999999 liters.

**ELAPSED TIME:** The small numbers below the mass total show the elapsed time since the last reset in hours, minutes and seconds. The maximum measurable elapsed time is 9999 hours 59 minutes 59 seconds. The hours count resets when **RESET** is pushed, an RS-232 or RS-485 clear is executed or on loss of power. Press **TOTAL/TIMER** to show this as the primary display.

**SETPT:** Pushing SETPT will allow you to change the controller's set-point.

**RESET** – The counter can be reset to zero at any time by pushing the RESET button. To clear the counter via RS-232 or RS-485, establish serial communication with the meter or controller as described in the RS-232 or RS-485 section of the manual. To reset the counter, enter the following commands:

In Polling (addressable) Mode: Address\$\$T <Enter> (e.g. B\$\$T <Enter>)



**WHEN USING A MASS FLOW CONTROLLER AS AN ABSOLUTE PRESSURE CONTROLLER,** THE MASS FLOW RATE MAY MOMENTARILY EXCEED THE FLOW MEASUREMENT CAPABILITY (FULL SCALE + 28%) OF THE UNIT. THIS MAY OCCUR WHEN THE UNIT IS ASKED TO MAKE AN ABRUPT PRESSURE CHANGE.

**IF THE TOTALIZER IS IN USE AT THAT TIME,** THE TOTALIZED VALUE WILL NECESSARILY BECOME INCORRECT. PLEASE RESET THE TOTALIZER IF SUCH AN 'OVER-FLOW' CONDITION HAS OCCURRED.

## BATCH PROCESSING MODE – CONTROLLERS ONLY

Batch mode is a function within the optional Totalizing mode. Batch mode is designed to provide repeatable, finite flow quantities.

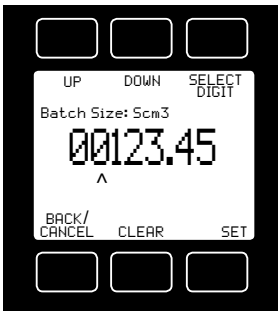

**To activate Batch Mode:** Press **BATCH**. Then use **SELECT DIGIT** to move the arrow to the desired digit, and the UP and DOWN buttons to change the value. Press **CLEAR** to return to zero. Press **SET** to record your value. If the controller has a non-zero Set-Point, flow will start immediately. If not, press **SETPT** to select a Set-Point.

Batch values can also be established via RS-232/RS-485 communication using Register 92. (See RS-232/RS-485 Section of this manual for serial communication methods.)

**Note:** While the Totalizer counter will still reset across power cycles, the Batch process value is stored in EEPROM and will remain valid until updated by the user.

While the Batch is processing, the remaining amount of the Batch value is displayed above **REMAIN** on the Totalizer screen. Time elapsed during the Batch processing is displayed below the totalizing counter. Press **TOTAL/TIMER** to toggle these values.

When the active Totalizer reaches the preset Batch value, flow ceases, and **REMAIN** updates to **Done Batch**. The Totalizer timer also pauses.



- **To start a new batch of the same size**, simply press RESET. The Totalizer can reproduce any number of fixed Batches in this manner.

- **To start a smaller batch**, decrease the Batch value. The new batch begins when you press RESET.

- **To continue the existing batch to a larger total volume**, increase the Batch value. Flow resumes as soon as you press OK in the Batch Value screen.

- **To start a larger batch from scratch**, first clear the flow Set-Point to zero to prevent unwanted flow.

Then increase the Batch value, and select a flow Set-Point. Flow will begin when you press **SET** in the Set-Point screen.

- **To cancel a batch in progress**, clear the Set-Point and press **SET**.

**Note:** Batch mode operates independently of the desired flow rate, but requires a non-zero flow rate to run. The rate of flow is determined by the controller Set-Point value, which is established by the user via analog, front panel or serial communication methods. Batches can be produced more slowly or more rapidly as determined by the user-selected Set-Point flow rate.

**To turn off Batch Mode:** Set the Batch value to zero (0.0) via the front panel or RS-232/RS-485 communication using Register 92. If there is a non-zero flow Set-Point, flow will immediately resume, and the Totalizer counter will continue per the user established Set-Point flow rate.

### Accessory: Multi-Drop Box



The **Multi-Drop Box** makes it convenient to wire multiple flow and/or pressure devices to a single RS-232 or RS-485 port. ***Now available with a USB interface!***

The Multi-Drop Box has nine 8 pin mini-DIN ports available. The ports are to be used with a standard double ended 8 pin mini-DIN style cable going from the box to each flow or pressure device.

A single DB9 D-SUB type connector (COM PORT) connects, using the included cable, to the serial connector on a PC or laptop.

All of the flow and/or pressure devices are powered via a terminal block on the front of the box.

If more than nine devices will be required, additional Multi-Drop Boxes can be daisy chained together with a double ended 8 pin mini-DIN cable plugged into any receptacle on both boxes.

**Power Supply for Large Valve Controllers:** The PS24VHC (Power Supply 24Vdc High Current) is a 6.5Amp 24Vdc power supply designed for running multiple large controllers on a Multi-Drop Box.

The 6.5Amp power supply can run as many as 8 large valve controllers, which makes it ideal for the Multi-Drop Box and multiple large valve (or small valve / large valve combination) controllers on a Multi-Drop Box.

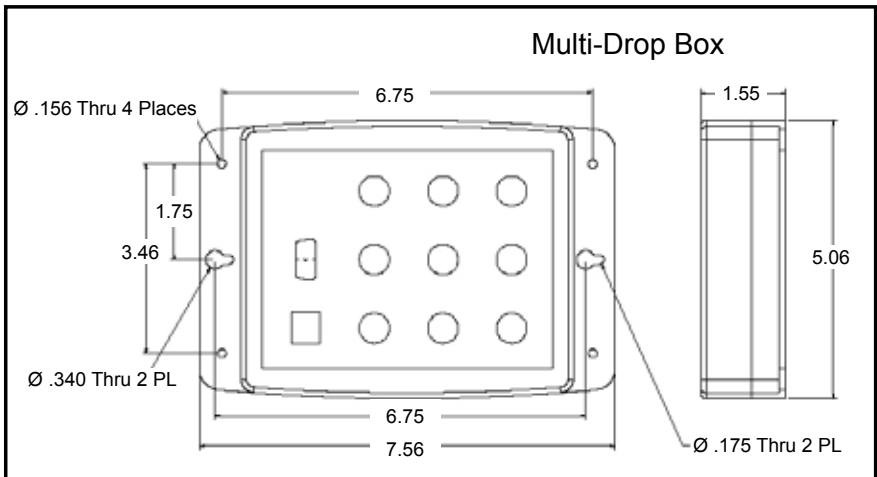

## Accessory: Flow Vision™ SC Software

**Flow Vision™ SC** is an intuitive software interface to help your test cycles run smoother and shorten your engineering time!

**Flow Vision™ SC** lets you connect to and communicate with multiple M-Series units simultaneously. Now you can view virtual displays, control tabs, charts and data lines from every connected M-Series device on the same screen.

**Flow Vision™ SC** supports all RS-232 and RS-485 Serial communication functions, including: **gas selection, taring, set-point control, valve tuning and flow averaging.**

**Session Saving:** Save and reload your configuration data with confidence.

**Script Building:** Create scripts to adjust a controller's set-point value at variable specified time intervals.

**Charting:** Chart as many parameters as you want off as many devices as you want, with color coding, zooming, and printing functionality.

**Alarms:** Create software alarms that will notify you of given parameter conditions.

**Data Capture & Logging:** Capture and log data to either a .csv file or a .txt file. Improved Data Logging and Data Log File Splitting for easy to manage data.

## Accessory: Flow Vision™ MX Software

**Flow Vision™ MX** software gives you an easy way to do **GAS BLENDING** using **MC Mass Flow Controllers** and your own PC.

**Flow Vision™ MX** software is a simple way to connect up to six M-Series mass flow controllers and create your own gas mix concentrations.

Using our inexpensive **Multi-drop box** and a single USB connection you can:

- **Create** your own gas blends
- **Adjust** flow rates
- **Save** your specific blend formulas.

All the controllers can be powered through the Multi-drop box with a single power supply.

Just connect your unique gases to each controller, select the gas type either locally on the controller or through Flow Vision™ MX, manifold the flow outputs and create your gas mix.

# Accessories

| Description   |
|---|
| Flow Vision™ SC software for interface with all MC-Series instruments         |
| Flow Vision™ MX software for gas blending                                     |
| 9 position Multi Drop Box with 9-pin serial port and USB to PC                |
| 9 position Multi-Drop Box, Industrial connectors                              |
| 9 position Multi Drop Box with serial port only                               |
| 9 position Multi-Drop Box, industrial connectors, serial port only            |
| Universal 100-240 VAC to 24 Volt DC Power Supply Adapter                      |
| High current power supply for Multi Drop Box use with Large Valve Controllers |
| micro-USB to wall adapter   |
| Industrial carry and storage case for up to 2 portable meters/gauges          |
| Industrial carry and storage case for up to 6 meters and controllers          |
| 8 Pin Male Mini-DIN connector cable, single ended, 6 foot length              |
| 8 Pin Male Right Angle Mini-DIN Cable, single ended, 6 foot length            |
| 8 Pin Male Mini-DIN connector cable, single ended, 25 foot length             |
| 8 Pin Male Mini-DIN connector cable, single ended, 50 foot length             |
| 8 Pin Male Mini-DIN connector cable, single ended, 75 foot length             |
| 8 Pin Male Mini-DIN connector cable, single ended, 100 foot length            |
| 8-pin Male Mini-DIN connector cable, double ended, no analog, 3 foot length   |
| 8-pin Male Mini-DIN connector cable, double ended, no analog, 6 foot length   |
| 8 Pin Male Mini-DIN connector cable, double ended, 6 foot length              |
| 8 Pin Male Mini-DIN connector cable, double ended, 25 foot length             |
| 8 Pin Male Mini-DIN connector cable, double ended, 50 foot length             |
| 8 Pin Male Mini-DIN to DB9 Female Adapter, 6 foot length                      |
| DB15 cable, single ended, 25 foot length                                      |
| DB9 cable, double-ended female, 3 meter length                                |
| Industrial cable, 6 Pin, single ended, 10 foot length                         |
| Industrial cable, 6 Pin, single ended, 20 foot length                         |
| Industrial cable, 6 Pin, single ended, 50 foot length                         |
| Industrial cable, 6 pin double ended, 10 foot length                          |
| RS-232 to USB Converter   |

# Accessories

| MNPT to Compression Fittings |               |
|------------------------------|---------------|
| 10-32 - 1/8"                 | SS-200-1-0157 |
| 10-32 - 1/4"                 | SS-400-1-0256 |
| 1/8" - 1/8"                  | SS-200-1-2    |
| 1/8" - 1/4"                  | SS-400-1-2    |
| 1/8" - 3/8"                  | SS-600-1-2    |
| 1/8" - 1/2"                  | SS-810-1-2    |
| 1/8" - 3mm                   | SS-3M0-1-2    |
| 1/8" - 4mm                   | SS-4M0-1-2    |
| 1/8" - 6mm                   | SS-6M0-1-2    |
| 1/8" - 8mm                   | SS-8M0-1-2    |
| 1/8" - 12mm                  | SS-12M0-1-2   |
| 1/4" - 1/8"                  | SS-200-1-4    |
| 1/4" - 1/4"                  | SS-400-1-4    |
| 1/4" - 3/8"                  | SS-600-1-4    |
| 1/4" - 1/2"                  | SS-810-1-4    |
| 1/4" - 3mm                   | SS-3M0-1-4    |
| 1/4" - 4mm                   | SS-4M0-1-4    |
| 1/4" - 6mm                   | SS-6M0-1-4    |
| 1/4" - 8mm                   | SS-8M0-1-4    |
| 1/4" - 12mm                  | SS-12M0-1-4   |
| 1/2" - 1/8"                  | SS-200-1-8    |
| 1/2" - 1/4"                  | SS-400-1-8    |
| 1/2" - 3/8"                  | SS-600-1-8    |
| 1/2" - 1/2"                  | SS-810-1-8    |
| 1/2" - 3/4"                  | SS-1210-1-8   |
| 1/2" - 6mm                   | SS-6M0-1-8    |
| 1/2" - 8mm                   | SS-8M0-1-8    |
| 1/2" - 12mm                  | SS-12M0-1-8   |
| 1/2" - 16mm                  | SS-16M0-1-8   |
| 3/4" - 1/4"                  | SS-400-1-12   |
| 3/4" - 1/2"                  | SS-810-1-12   |
| 3/4" - 3/4"                  | SS-1210-1-12  |
| 3/4" - 12mm                  | SS-12M0-1-12  |
| 3/4" - 16mm                  | SS-16M0-1-12  |

| Filters & Elements FNPT-MNPT |             |
|------------------------------|-------------|
| 10-32 5μ                     | 510053      |
| 10-32 20μ                    | 510054      |
| 1/8" 20μ                     | ILF-1/8-20  |
| 1/4" 40μ                     | ILF-1/4-40  |
| 1/2" 40μ                     | ILF-1/2-40* |
| 3/4" 40μ                     | ILF-3/4-40* |
| 20μ element                  | ILFE20      |
| 40μ element                  | ILFE40      |
| 40μ element                  | ILFE40L*    |

| Filters & Elements FNPT-FNPT*  |               |
|--|---------------|
| 10-32 5μ   | CF-303-20-316 |
| *requires MNPT to MNPT coupler to interface with MC-Series flow bodies |               |

| 10-32 Male UNF to 1/8 FNPT Adapter                         |  |
|--|--|
| 410133   |  |
| Male M5 (10-32) Buna-N O-ring face seal to 1/8" Female NPT |  |

## Technical Data for MC and MCR Mass Flow Controllers 0 to 0.5 sccm Full Scale through 0 to 5000 slpm Full Scale

### Standard Operating Specifications (Contact Your dealer for available options)

| Performance  | MC & MCR Mass Flow Controller  |
|--|--|
| Accuracy at calibration conditions after tare      | ± (0.8% of Reading + 0.2% of Full Scale)   |
| High Accuracy at calibration conditions after tare | ± (0.4% of Reading + 0.2% of Full Scale)<br>High Accuracy option not available for units ranged under 5 sccm or over 500 slpm. |
| Repeatability                                      | ± 0.2% Full Scale  |
| Zero Shift and Span Shift                          | 0.02% Full Scale / °Celsius / Atm  |
| Operating Range / Turndown Ratio                   | 0.5% to 100% Full Scale / 200:1 Turndown   |
| Maximum Controllable Flow Rate                     | 102.4% Full Scale  |
| Typical Response Time                              | 100 ms (Adjustable)  |
| Warm-up Time                                       | < 1 Second   |

| Operating Conditions            | MC & MCR Mass Flow Controller  |
|---------------------------------|--|
| Mass Reference Conditions (STP) | 25°C & 14.696 psia (standard — others available on request)  |
| Operating Temperature           | -10 to +50 °Celsius  |
| Humidity Range (Non-Condensing) | 0 to 100%  |
| Max. Internal Pressure (Static) | 145 psig   |
| Proof Pressure                  | 175 psig   |
| Mounting Attitude Sensitivity   | <b>MC:</b> None <b>MCR:</b> Mount with valve cylinder vertical & upright   |
| Valve Type                      | Normally Closed  |
| Ingress Protection              | IP40   |
| Wetted Materials                | <b>MC:</b> 303 & 302 Stainless Steel, Viton®, Heat Cured Silicone Rubber, Glass Reinforced Polyphenylene Sulfide, Heat Cured Epoxy, Aluminum, Gold, Brass, 430FR Stainless Steel, Silicon, Glass.<br><b>MCR:</b> 303 & 302 Stainless Steel, Viton®, Heat Cured Silicone Rubber, Glass Reinforced Polyphenylene Sulfide, Heat Cured Epoxy, Aluminum, Gold, 416 Stainless Steel, Silicon, Glass. If your application demands a different material, please contact your dealer. |

| Communications / Power  | MC & MCR Mass Flow Controller  |
|---|--|
| Monochrome LCD or Color TFT Display with integrated touchpad  | Simultaneously displays Mass Flow, Volumetric Flow, Pressure and Temperature     |
| Digital Input/Output Signal <sup>1</sup> Options  | RS-232 Serial / RS-485 Serial / Modbus / PROFIBUS <sup>3</sup>                   |
| Analog Input/Output Signal <sup>2</sup> Options   | 0-5 Vdc / 1-5 Vdc / 0-10 Vdc / 4-20 mA   |
| Optional Secondary Analog Input/Output Signal <sup>2</sup>  | 0-5 Vdc / 1-5 Vdc / 0-10 Vdc / 4-20 mA   |
| Electrical Connection Options   | 8 Pin Mini-DIN / 9-pin D-sub (DB9) / 15-pin D-sub (DB15) / 6 pin locking         |
| Supply Voltage  | <b>MC:</b> 12 to 30 Vdc (15-30 Vdc for 4-20 mA outputs) <b>MCR:</b> 24 to 30 Vdc |
| Supply Current  | <b>MC:</b> 0.250 Amp <b>MCR:</b> 0.750 Amp ( <b>MCRH:</b> 2.0 Amp)               |
| <ol style="list-style-type: none"> <li>1. The <b>Digital Output Signal</b> communicates Mass Flow, Volumetric Flow, Pressure and Temperature</li> <li>2. The <b>Analog Output Signal</b> and <b>Optional Secondary Analog Output Signal</b> communicate your choice of Mass Flow, Volumetric Flow, Pressure or Temperature</li> <li>3. If selecting PROFIBUS, no analog signal is available. See PROFIBUS specifications for supply voltages and currents. PROFIBUS units do not have the display.</li> </ol> |  |

### Range Specific Specifications

| Full Scale Flow Mass Controller | Pressure Drop <sup>1</sup> at FS Flow (psid) venting to atmosphere | Mechanical Dimensions   | Process Connections <sup>2</sup>  |
|---------------------------------|--|-------------------------|---|
| <b>MC</b> 0.5 sccm to 50 sccm   | 1.0  | 3.9"H x 3.4"W x 1.1"D   | M-5 (10-32) Female Thread   |
| <b>MC</b> 100 sccm to 500 sccm  | 1.0  | 4.1"H x 3.6"W x 1.1"D   | 1/8" NPT Female   |
| <b>MC</b> 1 slpm                | 1.5  |                         |   |
| <b>MC</b> 2 slpm                | 3.0  |                         |   |
| <b>MC</b> 5 slpm                | 2.0  |                         |   |
| <b>MC</b> 10 slpm               | 5.5  |                         |   |
| <b>MC</b> 20 slpm               | 20.0   |                         |   |
| <b>MCR</b> 50 slpm              | 2.0  | 5.5"H x 7.7"W x 2.3"D   | 1/4" NPT Female   |
| <b>MCR</b> 100 slpm             | 3.2  | 5.5"H x 7.7"W x 2.3"D   | 1/2" NPT Female   |
| <b>MCR</b> 250 slpm             | 2.4  |                         |   |
| <b>MCR</b> 500 slpm             | 6.5  |                         |   |
| <b>MCR</b> 1000 slpm            | 14.0   |                         |   |
| <b>MCR</b> 1500 slpm            | 17.0   |                         |   |
| <b>MCR</b> 2000 slpm            | 28.6   |                         |   |
| <b>MCR</b> 3000 slpm            | 16.8   | 5.5"H x 8.1" W x 2.9" D | 3/4" NPT Female<br>(A 1-1/4" NPT Female process connection is available for 2000 slpm controllers.) |
| <b>MCRH</b> 5000 slpm           | 14.1   | 5.5"H x 8.9" W x 2.9" D | 1-1/4" NPT Female   |
|                                 |  | 6.3"H x 9.8"W x 4.5"D   | 2" NPT Female   |

1. Lower Pressure Drops Available, please see our **MCW-Series-Series** mass flow controllers.
2. Compatible with Swagelok® tube, Parker®, face seal, push connect and compression adapter fittings. VCR and SAE connections upon request.



**MC-Series:**

- 0 - 100 sccm
- 0 - 200 sccm
- 0 - 500 sccm
- 0 - 1 slpm
- 0 - 2 slpm
- 0 - 3 slpm
- 0 - 5 slpm
- 0 - 10 slpm
- 0 - 20 slpm

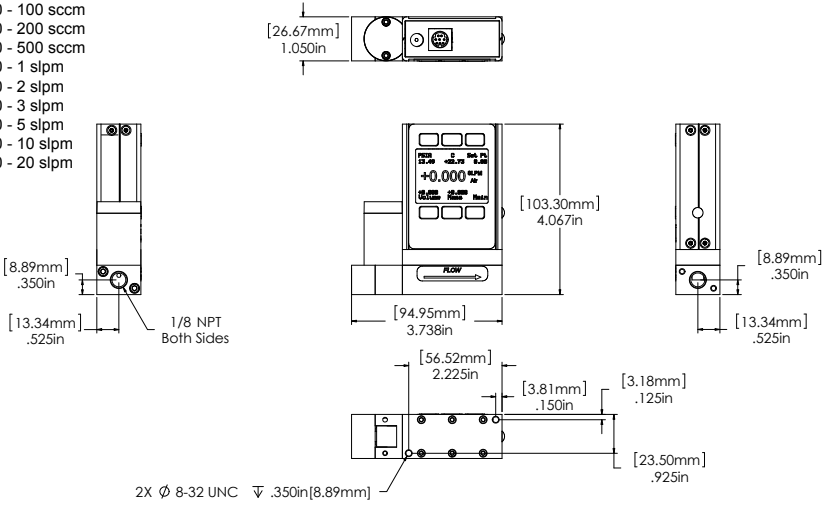

100 sccm to 20 slpm approximate weight: 1.2lb

**MCR-Series:**

- 0 - 50 slpm
- 0 - 100 slpm

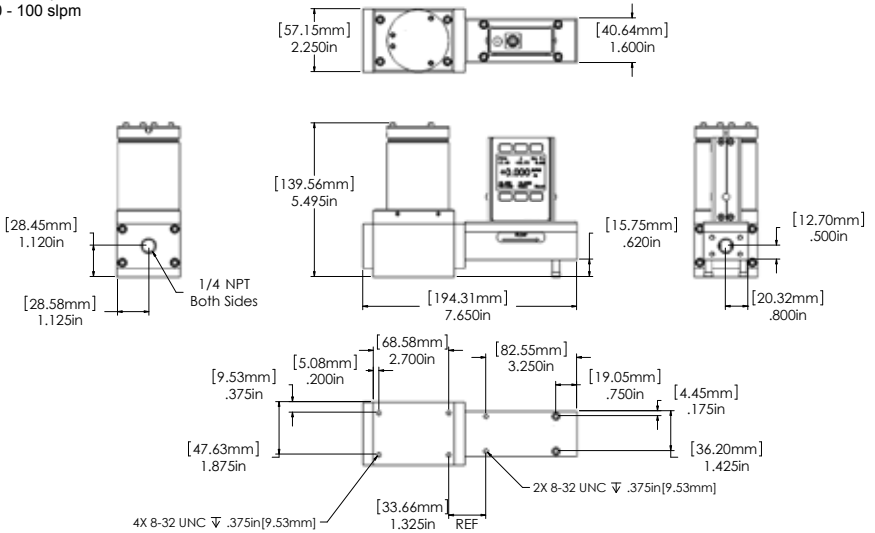

MCR 50 slpm to 100 slpm approximate weight: 9.0 lb.



**MCR-Series:**  
0 - 2000 slpm

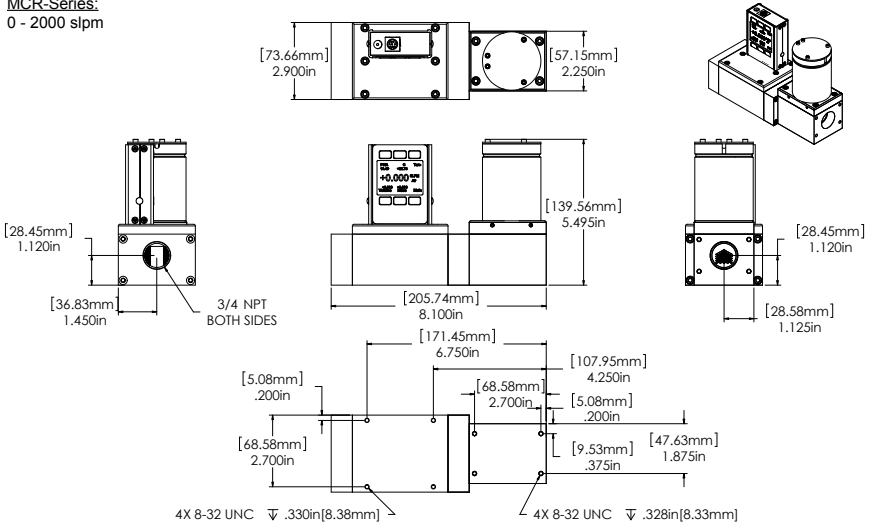

MCR 2000 slpm approximate weight: 12.0 lb.

**MCR-Series:**  
0 - 3000 slpm

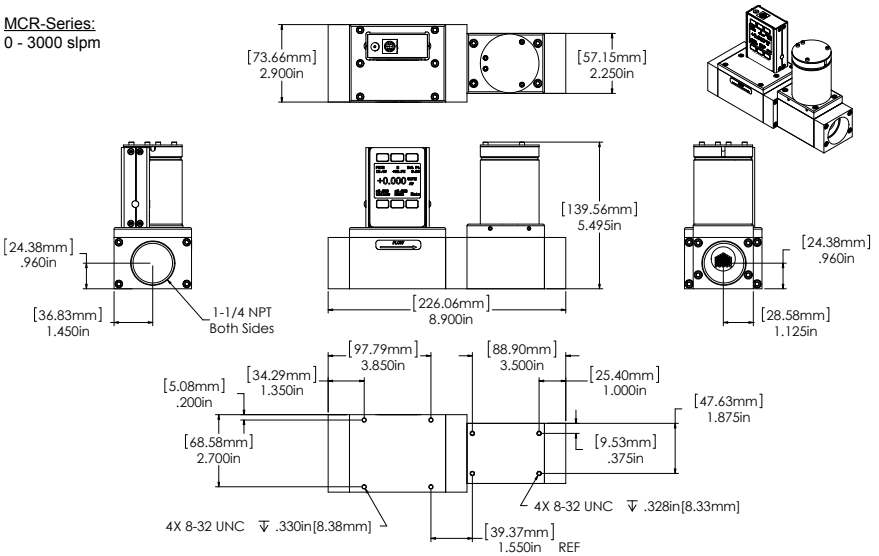

MCR 3000 slpm approximate weight: 12.0 lb.

**MCRH-Series**  
**0 - 5000 slpm**

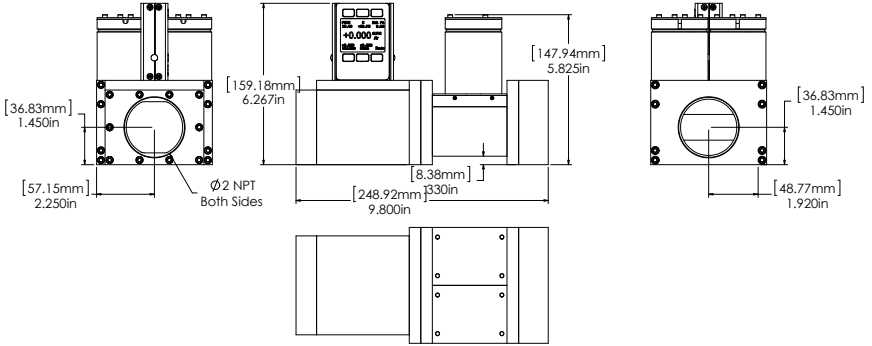
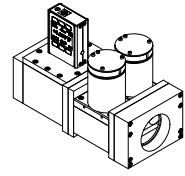
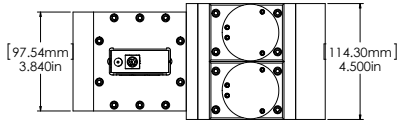

MCRH 5000 slpm approximate weight: 28.0 lb.

**Technical Data for MCW-Series Low Pressure Drop Mass Flow Controllers**  
**0 to 0.5 sccm Full Scale through 0 to 500 slpm Full Scale**  
**Standard Specifications (Contact Your dealer for available options.)**

| Performance  | MCW-Series MCW & MCRW Mass Flow Controller   |
|--|--|
| Accuracy at calibration conditions after tare      | ± (0.8% of Reading + 0.2% of Full Scale)   |
| High Accuracy at calibration conditions after tare | ± (0.4% of Reading + 0.2% of Full Scale)<br>High Accuracy option not available for units ranged under 5 sccm or over 500 slpm. |
| Repeatability                                      | ± 0.2% Full Scale  |
| Zero Shift and Span Shift                          | 0.02% Full Scale / °Celsius / Atm  |
| Operating Range / Turndown Ratio                   | 0.5% to 100% Full Scale / 200:1 Turndown   |
| Maximum Controllable Flow Rate                     | 102.4% Full Scale  |
| Typical Response Time                              | 100 ms (Adjustable)  |
| Warm-up Time                                       | < 1 Second   |

| Operating Conditions            | MCW-Series MCW & MCRW Mass Flow Controller  |
|---------------------------------|---|
| Mass Reference Conditions (STP) | 25°C & 14.696 psia (standard — others available on request)   |
| Operating Temperature           | -10 to +50 °Celsius   |
| Humidity Range (Non-Condensing) | 0 to 100%   |
| Max. Internal Pressure (Static) | 45 psig Higher line pressures available, please contact Your dealer.  |
| Proof Pressure                  | 175 psig  |
| Mounting Attitude Sensitivity   | <b>MCW:</b> None <b>MCRW:</b> Mount with valve cylinder vertical & upright  |
| Valve Type                      | Normally Closed   |
| Ingress Protection              | IP40  |
| Wetted Materials                | <b>MCW:</b> 303 & 302 Stainless Steel, Viton®, Silicone RTV (Rubber), Glass Reinforced Nylon, Aluminum, Brass, 430FR Stainless Steel, Silicon, Glass.<br><b>MCRW:</b> 303 & 302 Stainless Steel, Viton®, Silicone RTV (Rubber), Glass Reinforced Nylon, Aluminum, 416 Stainless Steel, Nickel, Silicon, Glass.<br>If your application demands a different material, please contact Your dealer. |

| Communications / Power                                       | MCW-Series MCW & MCRW Mass Flow Controller   |
|--|--|
| Monochrome LCD or Color TFT Display with integrated touchpad | Simultaneously displays Mass Flow, Volumetric Flow, Pressure and Temperature       |
| Digital Input/Output Signal <sup>1</sup> Options             | RS-232 Serial / RS-485 Serial / Modbus / PROFIBUS <sup>3</sup>                     |
| Analog Input/Output Signal <sup>2</sup> Options              | 0-5 Vdc / 1-5 Vdc / 0-10 Vdc / 4-20 mA   |
| Optional Secondary Analog Input/Output Signal <sup>2</sup>   | 0-5 Vdc / 1-5 Vdc / 0-10 Vdc / 4-20 mA   |
| Electrical Connection Options                                | 8 Pin Mini-DIN / 9-pin D-sub (DB9) / 15-pin D-sub (DB15) / 6 pin locking           |
| Supply Voltage   | <b>MCW:</b> 12 to 30 Vdc (15-30 Vdc for 4-20 mA outputs) <b>MCRW:</b> 24 to 30 Vdc |
| Supply Current   | <b>MCW:</b> 0.250 Amp <b>MCRW:</b> 0.750 Amp                                       |

1. The **Digital Output Signal** communicates Mass Flow, Volumetric Flow, Pressure and Temperature
2. The **Analog Output Signal** and **Optional Secondary Analog Output Signal** communicate your choice of Mass Flow, Volumetric Flow, Pressure or Temperature
3. If selecting PROFIBUS, no analog signal is available. See PROFIBUS specifications for supply voltages and currents. PROFIBUS units do not have the display.

**Range Specific Specifications**

| Full Scale Flow Mass Controller | Pressure Drop at FS Flow (psid) venting to atmosphere | Mechanical Dimensions | Process Connections <sup>1</sup>             |
|---------------------------------|---|-----------------------|--|
| <b>MCW</b> 0.5 sccm to 2 sccm   | 0.06  | 3.9"H x 3.4"W x 1.1"D | <b>M-5 (10-32) Female Thread<sup>2</sup></b> |
| <b>MCW</b> 5 sccm to 10 sccm    | 0.08  |                       |  |
| <b>MCW</b> 20 sccm              | 0.07  |                       |  |
| <b>MCW</b> 50 sccm to 200 sccm  | 0.07  |                       |  |
| <b>MCW</b> 500 sccm             | 0.08  | 4.1"H x 3.6"W x 1.1"D | 1/8" NPT Female                              |
| <b>MCW</b> 1 slpm               | 0.10  |                       |  |
| <b>MCW</b> 2 slpm               | 0.18  |                       |  |
| <b>MCRW</b> 5 slpm              | 0.10  | 5.5"H x 7.7"W x 2.3"D | 1/4" NPT Female                              |
| <b>MCRW</b> 10 slpm             | 0.12  |                       |  |
| <b>MCRW</b> 20 slpm             | 0.26  |                       |  |
| <b>MCRW</b> 40 slpm             | 0.14  |                       |  |
| <b>MCRW</b> 50 slpm             | 0.17  | 5.5"H x 7.3"W x 2.3"D | 3/4" NPT Female                              |
| <b>MCRW</b> 100 slpm            | 0.30  |                       |  |
| <b>MCRW</b> 250 slpm            | 0.69  |                       |  |
| <b>MCRW</b> 500 slpm            | 0.69  | 5.5"H x 8.1"W x 2.7"D | 3/4" NPT Female                              |

1. Compatible with Swagelok® tube, Parker®, face seal, push connect and compression adapter fittings. VCR and SAE connections upon request.
2. Shipped with M-5 (10-32) Male Buna-N O-ring face seal to 1/8" Female NPT fittings.

**MCW-Series MCW:**

- 0 - 0.5 sccm
- 0 - 1 sccm
- 0 - 2 sccm
- 0 - 5 sccm
- 0 - 10 sccm
- 0 - 20 sccm

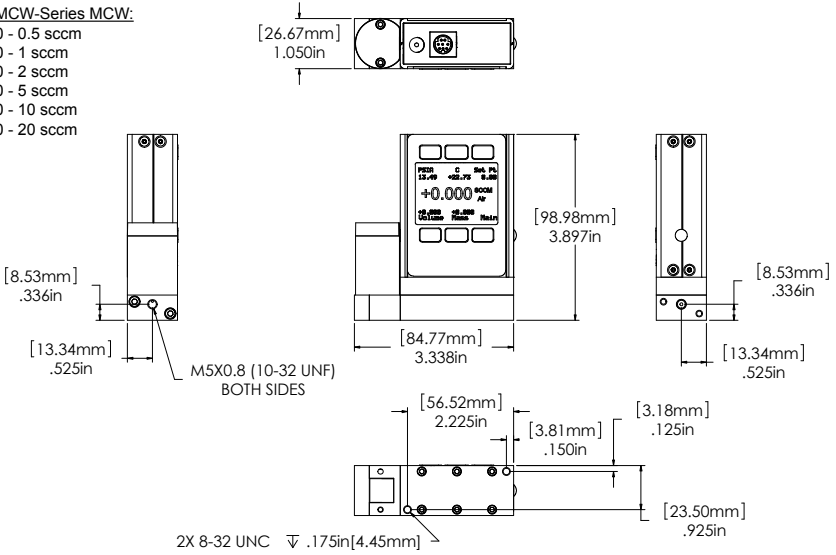

MCW 0.5 sccm to 20 sccm approximate shipping weight: 1.1 lb.

**MCW-Series MCW:**

- 0 - 50 sccm
- 0 - 100 sccm
- 0 - 200 sccm
- 0 - 500 sccm
- 0 - 1 slpm
- 0 - 2 slpm

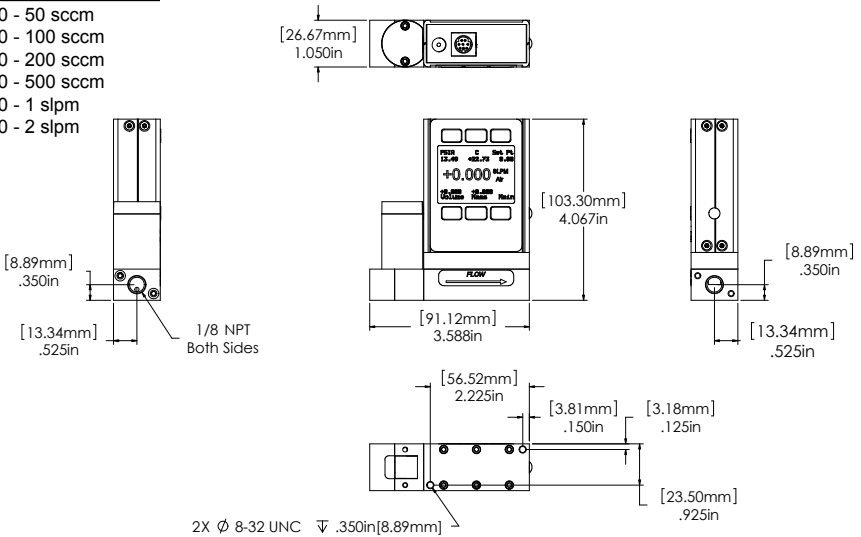

MCW 50 sccm to 2 slpm approximate weight: 1.2lb



**MCW-Series MCRW:**

- 0 - 50 slpm
- 0 - 100 slpm
- 0 - 250 slpm

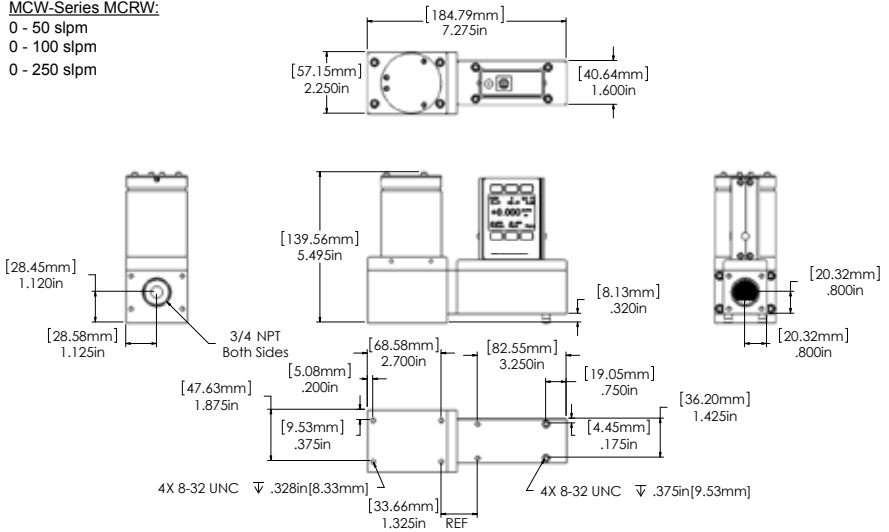

MCRW 50 slpm to 250 slpm approximate weight: 9.0 lb.

**MCW-Series MCRW:**

- 0 - 500 slpm

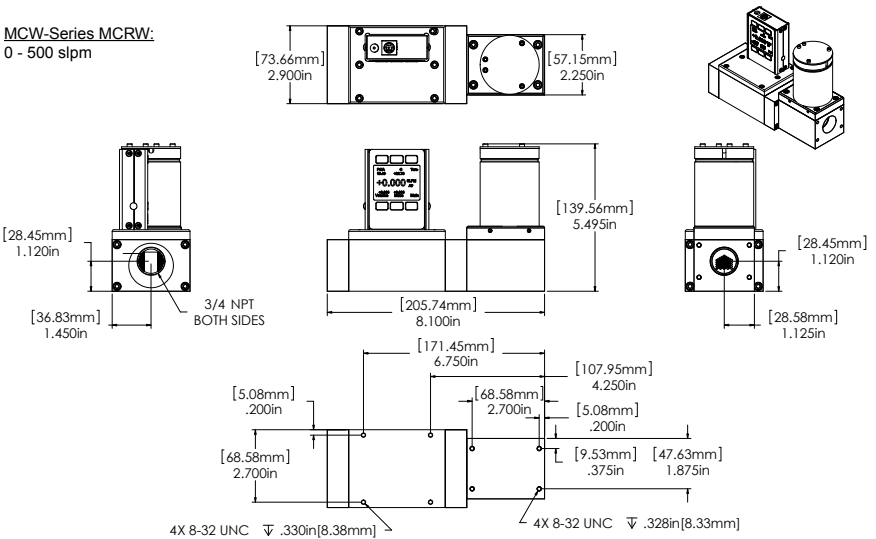

MCRW 500 slpm approximate weight: 11.0 lb.

## Technical Data for MCV & MCVS Mass Flow Controllers

0 to 0.5 sccm Full Scale through 0 to 20 slpm Full Scale

The **MCV** mass flow controller is designed for applications that require tight shut-off such as vacuum coating and sputtering processes. An integrated pneumatic shut-off valve is normally closed and provides positive shut-off of  $1 \times 10^{-9}$  atm scc/sec Helium max.

**MCVS** controllers are for use with aggressive gases.

### Standard Specifications (Contact Your dealer for available options.)

| Performance  | MCV Mass Flow Controller  | MCVS Mass Flow Controller              |
|--|---|--|
| Accuracy at calibration conditions after tare      | $\pm$ (0.8% of Reading + 0.2% of Full Scale)  |  |
| High Accuracy at calibration conditions after tare | $\pm$ (0.4% of Reading + 0.2% of Full Scale)<br>High Accuracy option not available for units ranged under 5 sccm.   |  |
| Repeatability                                      | $\pm$ 0.2% Full Scale   |  |
| Zero Shift and Span Shift                          | 0.02% Full Scale / °Celsius / Atm   |  |
| Operating Range / Turndown Ratio                   | 0.5% to 100% Full Scale / 200:1 Turndown  | 1% to 100% Full Scale / 100:1 Turndown |
| Maximum Controllable Flow Rate                     | 102.4% Full Scale   |  |
| Typical Response Time                              | 100 ms (Adjustable)   |  |
| Warm-up Time                                       | < 1 Second  |  |
| Integrated Valve Leak Integrity                    | $1 \times 10^{-9}$ atm scc/sec Helium max   |  |
| Operating Conditions                               | MCV Mass Flow Controller  | MCVS Mass Flow Controller              |
| Mass Reference Conditions (STP)                    | 25°C & 14.696 psia (standard — others available on request)   |  |
| Operating Temperature                              | -10 to +50 °Celsius   |  |
| Humidity Range (Non-Condensing)                    | 0 to 100%   |  |
| Max. Internal Pressure (Static)                    | 145 psig  |  |
| Proof Pressure                                     | 175 psig  |  |
| Mounting Attitude Sensitivity                      | None  |  |
| Valve Type   | Normally Closed   |  |
| Ingress Protection                                 | IP40  |  |
| Wetted Materials                                   | <b>MCV:</b> 303 & 302 Stainless Steel, Viton®, Heat Cured Silicone Rubber, Glass Reinforced Polyphenylene Sulfide, Heat Cured Epoxy, Aluminum, Gold, Brass, 430FR Stainless Steel, Silicon, Glass.<br><b>MCVS:</b> 316LSS, 303SS, 430FRSS, FFKM (Kalrez) standard, Viton, EPDM, Buna, Neoprene as needed for some gases.<br>If your application demands a different material, please contact Your dealer. |  |

| Communications / Power  | MCW-Series MCV & MCVS Mass Flow Controller                                   |
|---|--|
| Monochrome LCD or Color TFT Display with integrated touchpad  | Simultaneously displays Mass Flow, Volumetric Flow, Pressure and Temperature |
| Digital Input/Output Signal <sup>1</sup> Options  | RS-232 Serial / RS-485 Serial / Modbus / PROFIBUS <sup>3</sup>               |
| Analog Input/Output Signal <sup>2</sup> Options   | 0-5 Vdc / 1-5 Vdc / 0-10 Vdc / 4-20 mA                                       |
| Optional Secondary Analog Input/Output Signal <sup>2</sup>  | 0-5 Vdc / 1-5 Vdc / 0-10 Vdc / 4-20 mA                                       |
| Electrical Connection Options   | 8 Pin Mini-DIN / 9-pin D-sub (DB9) / 15-pin D-sub (DB15) / 6 pin locking     |
| Supply Voltage  | 12 to 30 Vdc (15-30 Vdc for 4-20 mA outputs)                                 |
| Supply Current  | 0.250 Amp  |
| 1. The <b>Digital Output Signal</b> communicates Mass Flow, Volumetric Flow, Pressure and Temperature<br>2. The <b>Analog Output Signal</b> and <b>Optional Secondary Analog Output Signal</b> communicate your choice of Mass Flow, Volumetric Flow, Pressure or Temperature<br>3. If selecting PROFIBUS, no analog signal is available. See PROFIBUS specifications for supply voltages and currents. PROFIBUS units do not have the display. |  |

### Range Specific Specifications

| Full Scale Mass Flow Controller  | Mechanical Dimensions | Process Connections |
|--|-----------------------|---------------------|
| <b>MCV</b> 0.5SCCM to 20SLPM   | 4.8"H x 6.8"W x 1.5"D | 1/4" VCR® Male      |
| <b>MCVS</b> 0.5SCCM to 20SLPM  | 5.5"H x 6.8"W x 1.5"D | 1/4" VCR® Male      |
| Welded VCR® process connections are recommended for MCV and MCVS applications. Please contact Your dealer. |                       |                     |

**MCV-Series**

All ranges

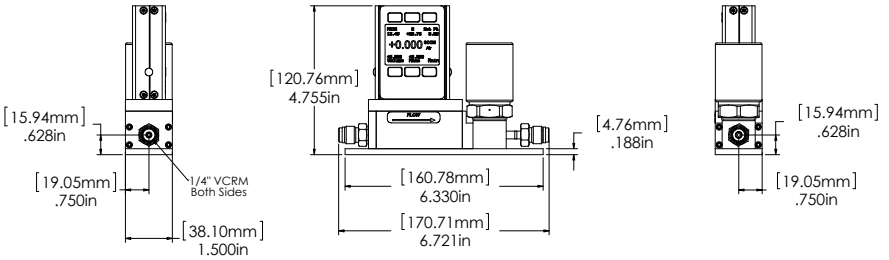
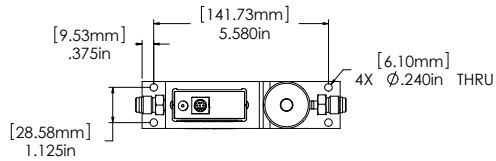

MCV approximate weight: 3.0 lb.

**MCVS-Series**

All ranges

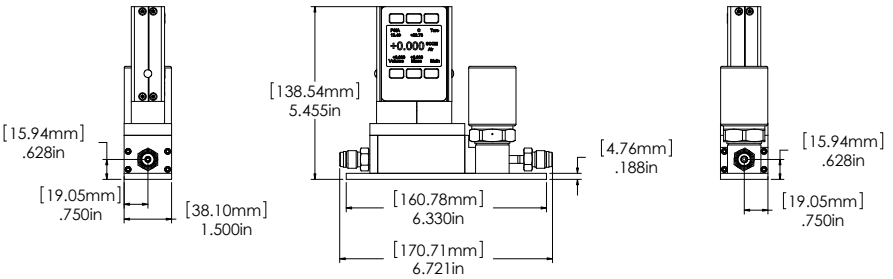
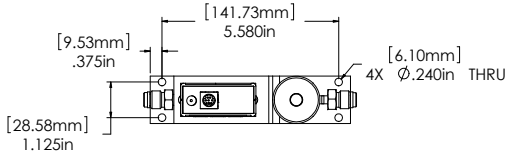

MCVS approximate weight: 3.2 lb.

## Technical Data for MCP Moderate Flow Mass Flow Controllers 0 to 50 slpm Full Scale through 0 to 250 slpm Full Scale

MCP mass flow controllers are fitted with a high performance valve for low pressure applications. The following specifications are applicable to MCP-Series Mass Flow Controllers only.

**Please Note Maximum Pressure of 80 psig.**

**Standard Operating Specifications (Contact Your dealer for available options)**

| Performance  | MCP Mass Flow Controller                 |
|--|--|
| Accuracy at calibration conditions after tare      | ± (0.8% of Reading + 0.2% of Full Scale) |
| High Accuracy at calibration conditions after tare | ± (0.4% of Reading + 0.2% of Full Scale) |
| Repeatability                                      | ± 0.2% Full Scale                        |
| Zero Shift and Span Shift                          | 0.02% Full Scale / °Celsius / Atm        |
| Operating Range / Turndown Ratio                   | 0.5% to 100% Full Scale / 200:1 Turndown |
| Maximum Controllable Flow Rate                     | 102.4% Full Scale                        |
| Typical Response Time                              | 100 ms (Adjustable)                      |
| Warm-up Time                                       | < 1 Second                               |

| Operating Conditions            | MCP Mass Flow Controller  |
|---------------------------------|---|
| Mass Reference Conditions (STP) | 25°C & 14.696 psia (standard — others available on request)   |
| Operating Temperature           | -10 to +50 °Celsius   |
| Humidity Range (Non-Condensing) | 0 to 100%   |
| Max. Internal Pressure (Static) | 80 psig   |
| Proof Pressure                  | 175 psig  |
| Mounting Attitude Sensitivity   | None  |
| Valve Type                      | Normally Closed   |
| Ingress Protection              | IP40  |
| Wetted Materials                | 303 & 302 Stainless Steel, Viton®, Heat Cured Silicone Rubber, Glass Reinforced Polyphenylene Sulfide, Heat Cured Epoxy, Aluminum, Gold, Brass, 430FR Stainless Steel, Silicon, Glass.<br>If your application demands a different material, please contact Your dealer. |

| Communications / Power                                       | MCP Mass Flow Controller   |
|--|--|
| Monochrome LCD or Color TFT Display with integrated touchpad | Simultaneously displays Mass Flow, Volumetric Flow, Pressure and Temperature |
| Digital Input/Output Signal <sup>1</sup> Options             | RS-232 Serial / RS-485 Serial / Modbus / PROFIBUS <sup>3</sup>               |
| Analog Input/Output Signal <sup>2</sup> Options              | 0-5 Vdc / 1-5 Vdc / 0-10 Vdc / 4-20 mA                                       |
| Optional Secondary Analog Input/Output Signal <sup>2</sup>   | 0-5 Vdc / 1-5 Vdc / 0-10 Vdc / 4-20 mA                                       |
| Electrical Connection Options                                | 8 Pin Mini-DIN / 9-pin D-sub (DB9) / 15-pin D-sub (DB15) / 6 pin locking     |
| Supply Voltage   | 12 to 30 Vdc (15-30 Vdc for 4-20 mA outputs)                                 |
| Supply Current   | 0.250 Amp  |

1. The **Digital Output Signal** communicates Mass Flow, Volumetric Flow, Pressure and Temperature
2. The **Analog Output Signal** and **Optional Secondary Analog Output Signal** communicate your choice of Mass Flow, Volumetric Flow, Pressure or Temperature
3. If selecting PROFIBUS, no analog signal is available. See PROFIBUS specifications for supply voltages and currents. PROFIBUS units do not have the display.

### Range Specific Specifications

| Full Scale Flow Mass Controller | Pressure Drop <sup>1</sup> at FS Flow (psid) venting to atmosphere | Mechanical Dimensions | Process Connections <sup>2</sup> |
|---------------------------------|--|-----------------------|----------------------------------|
| MCP 50 slpm                     | 7  | 4.4"H x 5.4"W x 1.6"D | 1/4" NPT Female                  |
| MCP 100 slpm                    | 20   |                       |                                  |
| MCP 250 slpm                    | 60   | 5.0"H x 6.3"W x 1.6"D | 1/2" NPT Female                  |

1. Lower Pressure Drops Available, please see our **MCW-Series-Series** mass flow controllers.
2. Compatible with Swagelok® tube, Parker®, face seal, push connect and compression adapter fittings. VCR and SAE connections upon request.

**MCP-Series:**  
 50 slpm  
 100 slpm

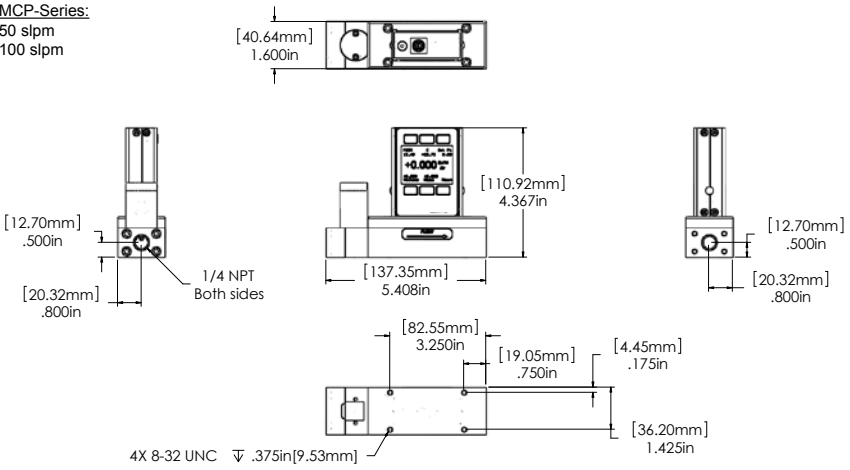

10 slpm to 50 slpm approximate shipping weight: 3.0 lb.

**MCP-Series SAE**  
 0 - 50 slpm  
 0 - 100 slpm

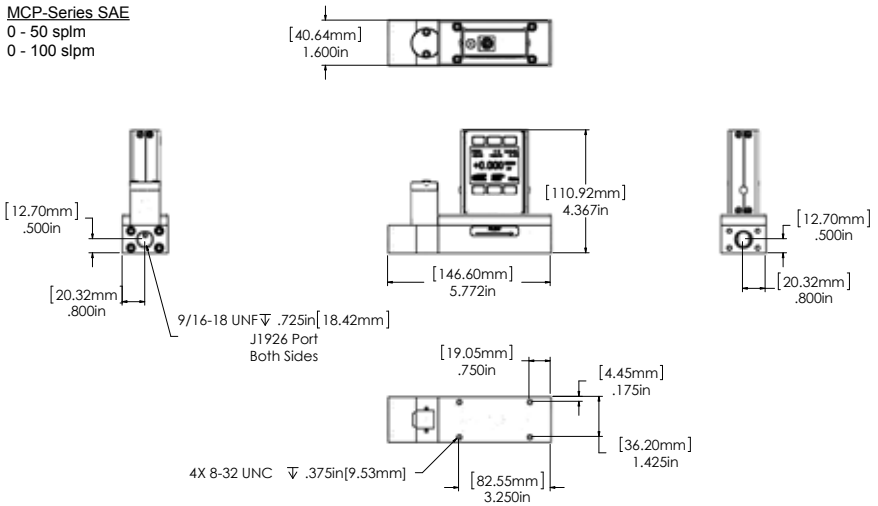

50 slpm to 100 slpm approximate shipping weight: 3.2 lb.

**MCP-Series:**  
250 slpm

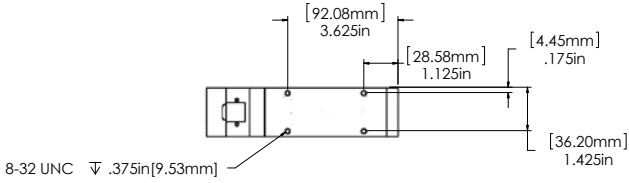
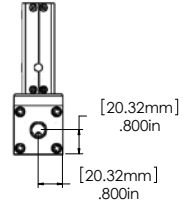
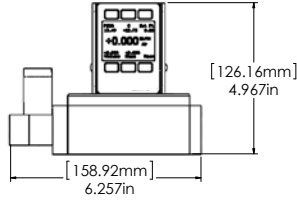
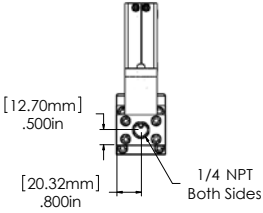

100 slpm to 250 slpm approximate shipping weight: 4.4 lb.

# Technical Data for MCD and MCRD Dual Valve Mass Flow Controllers 0 to 0.5 sccm Full Scale through 0 to 3000 slpm Full Scale

**Standard Operating Specifications (Contact Your dealer for available options)**

| Performance   | MCD Mass Flow Controller   | MCRD Mass Flow Controller |
|---|--|---------------------------|
| Accuracy for Bidirectional Controllers at calibration conditions after tare | ± (0.8% of reading + 0.2% of total span from positive full scale to negative full scale) |                           |
| Repeatability   | ± 0.2% Full Scale  |                           |
| Zero Shift and Span Shift   | 0.02% Full Scale / °Celsius / Atm  |                           |
| Operating Range / Turndown Ratio  | 0.5% to 100% Full Scale / 200:1 Turndown   |                           |
| Maximum Controllable Flow Rate  | 102.4% Full Scale  |                           |
| Typical Response Time   | 100 ms (Adjustable)  |                           |
| Warm-up Time  | < 1 Second   |                           |

| Operating Conditions            | MCD Mass Flow Controller  | MCRD Mass Flow Controller                    |
|---------------------------------|---|--|
| Mass Reference Conditions (STP) | 25°C & 14.696 psia (standard — others available on request)   |  |
| Operating Temperature           | -10 to +50 °Celsius   |  |
| Humidity Range (Non-Condensing) | 0 to 100%   |  |
| Max. Internal Pressure (Static) | 145 psig  |  |
| Proof Pressure                  | 175 psig  |  |
| Mounting Attitude Sensitivity   | None  | Mount with valve cylinder vertical & upright |
| Valve Type                      | Normally Closed   |  |
| Ingress Protection              | IP40  |  |
| Wetted Materials                | <b>MCD:</b> 303 & 302 Stainless Steel, Viton®, Heat Cured Silicone Rubber, Glass Reinforced Polyphenylene Sulfide, Heat Cured Epoxy, Aluminum, Gold, Brass, 430FR Stainless Steel, Silicon, Glass..<br><b>MCRD:</b> 303 & 302 Stainless Steel, Viton®, Heat Cured Silicone Rubber, Glass Reinforced Polyphenylene Sulfide, Heat Cured Epoxy, Aluminum, Gold, 416 Stainless Steel, Silicon, Glass. If your application demands a different material, please contact your dealer. |  |

| Communications / Power                                       | MCD Mass Flow Controller   | MCRD Mass Flow Controller |
|--|--|---------------------------|
| Monochrome LCD or Color TFT Display with integrated touchpad | Simultaneously displays Mass Flow, Volumetric Flow, Pressure and Temperature |                           |
| Digital Input/Output Signal <sup>1</sup> Options             | RS-232 Serial / RS-485 Serial / Modbus / PROFIBUS <sup>3</sup>               |                           |
| Analog Input/Output Signal <sup>2</sup> Options              | 0-5 Vdc / 1-5 Vdc / 0-10 Vdc / 4-20 mA                                       |                           |
| Optional Secondary Analog Input/Output Signal <sup>2</sup>   | 0-5 Vdc / 1-5 Vdc / 0-10 Vdc / 4-20 mA                                       |                           |
| Electrical Connection Options                                | 8 Pin Mini-DIN / 9-pin D-sub (DB9) / 15-pin D-sub (DB15) / 6 pin locking     |                           |
| Supply Voltage   | 12 to 30 Vdc (15-30 Vdc for 4-20 mA outputs)                                 | 24 to 30 Vdc              |
| Supply Current   | 0.250 Amp  | 0.750 Amp                 |

1. The **Digital Output Signal** communicates Mass Flow, Volumetric Flow, Pressure and Temperature
2. The **Analog Output Signal** and **Optional Secondary Analog Output Signal** communicate your choice of Mass Flow, Volumetric Flow, Pressure or Temperature
3. If selecting PROFIBUS, no analog signal is available. See PROFIBUS specifications for supply voltages and currents. PROFIBUS units do not have the display.

## Range Specific Specifications

| Full Scale Flow Mass Controller | Pressure Drop <sup>1</sup> at FS Flow (psid) venting to atmosphere | Mechanical Dimensions                   | Process Connections <sup>2</sup>   |                   |
|---------------------------------|--|---|--|-------------------|
| <b>MCD</b> 0.5 sccm to 50 sccm  | 1.0  | Dimensions will vary with valve choice. | M-5 (10-32) Female Thread  |                   |
| <b>MCD</b> 100 sccm to 500 sccm | 1.0  |   | 1/8" NPT Female  |                   |
| <b>MCD</b> 1 slpm               | 1.5  |   |  |                   |
| <b>MCD</b> 2 slpm               | 3.0  |   |  |                   |
| <b>MCD</b> 5 slpm               | 2.0  |   |  |                   |
| <b>MCD</b> 10 slpm              | 5.5  |   |  |                   |
| <b>MCD</b> 20 slpm              | 20.0   |   |  |                   |
| <b>MCRD</b> 50 slpm             | 2.0  |   |  |                   |
| <b>MCRD</b> 100 slpm            | 3.2  |   |  | 1/4" NPT Female   |
| <b>MCRD</b> 250 slpm            | 2.4  |   |  | 1/2" NPT Female   |
| <b>MCRD</b> 500 slpm            | 6.5  |   |  | 3/4" NPT Female   |
| <b>MCRD</b> 1000 slpm           | 14.0   |   | (A 1-1/4" NPT Female process connection is available for 2000 slpm controllers.) |                   |
| <b>MCRD</b> 1500 slpm           | 17.0   |   |  |                   |
| <b>MCRD</b> 2000 slpm           | 28.6   |   |  |                   |
| <b>MCRD</b> 3000 slpm           | 16.8   |   |  | 1-1/4" NPT Female |

1. Lower Pressure Drops Available, please see our **MCW-Series-Series** mass flow controllers.
2. Compatible with Swagelok® tube, Parker®, face seal, push connect and compression adapter fittings. VCR and SAE connections upon request.

**MCD-Series**  
0 - 20 slpm shown

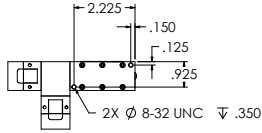
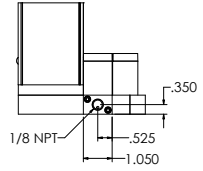
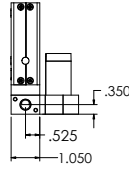
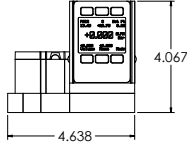
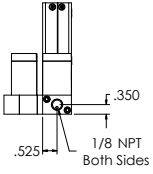
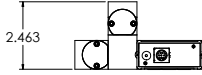

**MCRD-Series**  
0 - 2000 slpm shown

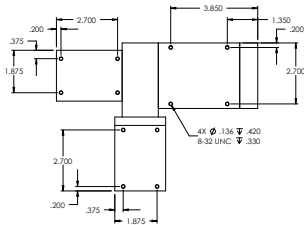
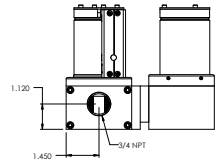
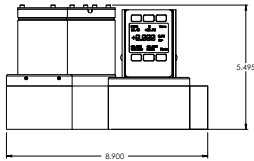
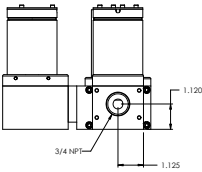
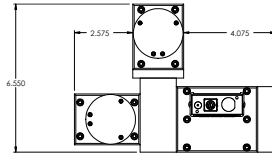

## Technical Data for MCS and MCRS-Series Mass Flow Controllers

MCS and MCRS instruments are built for use with aggressive gases. For the most part, these instruments maintain the specifications of equivalently ranged MC and MCR-Series devices.

### Standard Compatible Gas List for MCS and MCRS Controllers

|    |                     |         |
|----|---------------------|---------|
| 0  | Air                 | Air     |
| 1  | Argon               | Ar      |
| 2  | Methane             | CH4     |
| 3  | Carbon Monoxide     | CO      |
| 4  | Carbon Dioxide      | CO2     |
| 5  | Ethane              | C2H6    |
| 6  | Hydrogen            | H2      |
| 7  | Helium              | He      |
| 8  | Nitrogen            | N2      |
| 9  | Nitrous Oxide       | N2O     |
| 10 | Neon                | Ne      |
| 11 | Oxygen              | O2      |
| 12 | Propane             | C3H8    |
| 13 | normal-Butane       | n-C4H10 |
| 14 | Acetylene           | C2H2    |
| 15 | Ethylene            | C2H4    |
| 16 | iso-Butane          | i-C4H10 |
| 17 | Krypton             | Kr      |
| 18 | Xenon               | Xe      |
| 19 | Sulfur Hexafluoride | SF6     |
| 20 | 75%Ar / 25% CO2     | C-25    |
| 21 | 90% Ar / 10% CO2    | C-10    |
| 22 | 92% Ar / 8% CO2     | C-8     |

|  |   |        |
|--|---|--------|
| 23   | 98% Ar / 2% CO2                                   | C-2    |
| 24   | 75% CO2 / 25% Ar                                  | C-75   |
| 25   | 75% Ar / 25% He                                   | HE-75  |
| 26   | 75% He / 25% Ar                                   | HE-25  |
| 27   | 90% He / 7.5% Ar /<br>2.5% CO2<br>Helistar® A1025 | A1025  |
| 28   | 90% Ar / 8% CO2 /<br>2% O2<br>Stargon® CS         | Star29 |
| 29   | 95% Ar / 5% CH4                                   | P-5    |
| 30   | Nitric Oxide                                      | NO     |
| 31   | Nitrogen Trifluoride                              | NF3    |
| 32   | Ammonia   | NH3    |
| 34   | Hydrogen Sulfide                                  | H2S    |
| 36   | Propylene   | C3H6   |
| In addition, the following gases are available upon request: |   |        |
| Nitrogen Dioxide to 0.5%<br>in an inert carrier              |   | NO2    |
| Refrigerant gases to 100%                                    |   |        |
| Other gases to 1000 ppm in an inert carrier                  |   |        |

If your application requires another gas or gas mixture, please contact your dealer.

Please refer to the Technical Data and Specifications for the equivalently ranged MC and MCR-Series instrument for all operating specifications except:

|                  |   |
|------------------|---|
| Operating Range  | 1% to 100% Full Scale   |
| Turndown Ratio   | 100 : 1   |
| Wetted Materials | 316LSS, 303SS, 430FRSS, FFKM (Kalrez) standard, Viton, EPDM as needed for some gases. |

The dimensions of MCS and MCRS instruments may vary from their standard MC and MCR-Series counterparts. Dimensional drawings for MCS and MCRS instruments are shown on pages 79 -82

**MCS-Series:**

- 0 – 0.5 sccm
- 0 – 1 sccm
- 0 – 2 sccm
- 0 – 5 sccm
- 0 – 10 sccm
- 0 – 20 sccm
- 0 – 50 sccm

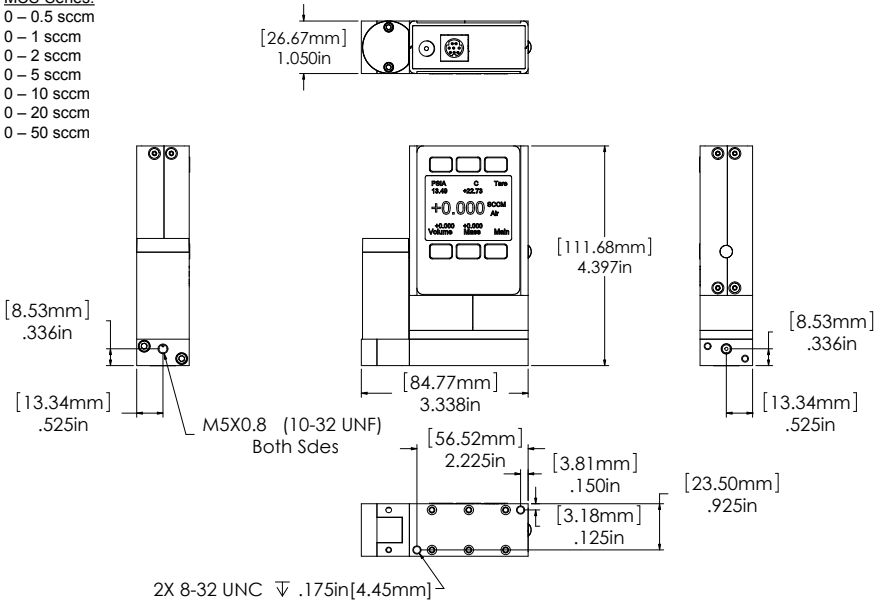

0.5 sccm to 50 sccm approximate shipping weight: 1.1 lb.

**MCS-Series:**

- 0 – 100 sccm
- 0 – 200 sccm
- 0 – 500 sccm
- 0 – 1 slpm
- 0 – 2 slpm
- 0 – 5 slpm
- 0 – 10 slpm
- 0 – 20 slpm

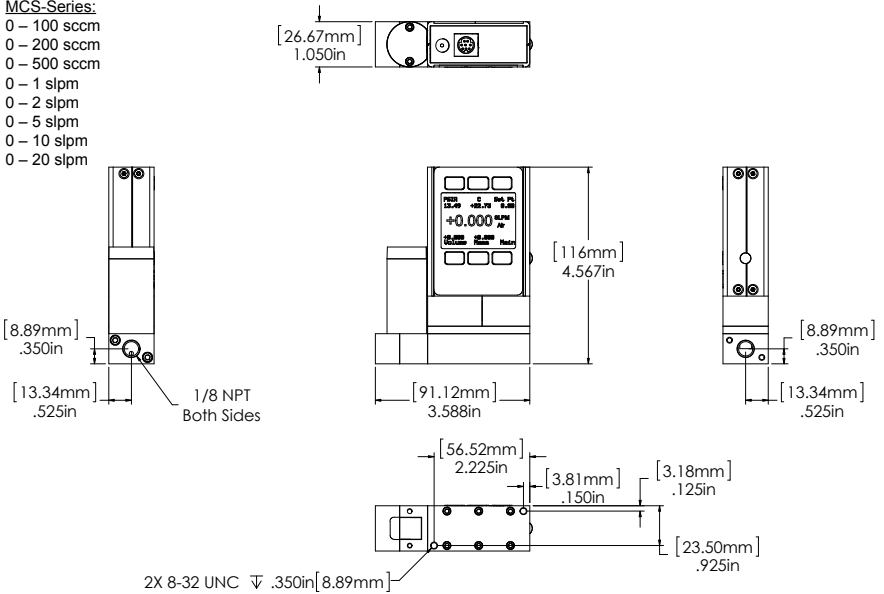

100 sccm to 20 slpm approximate weight: 1.2 lb

**MCRS-Series:**

0 – 50 slpm  
0 – 100 slpm

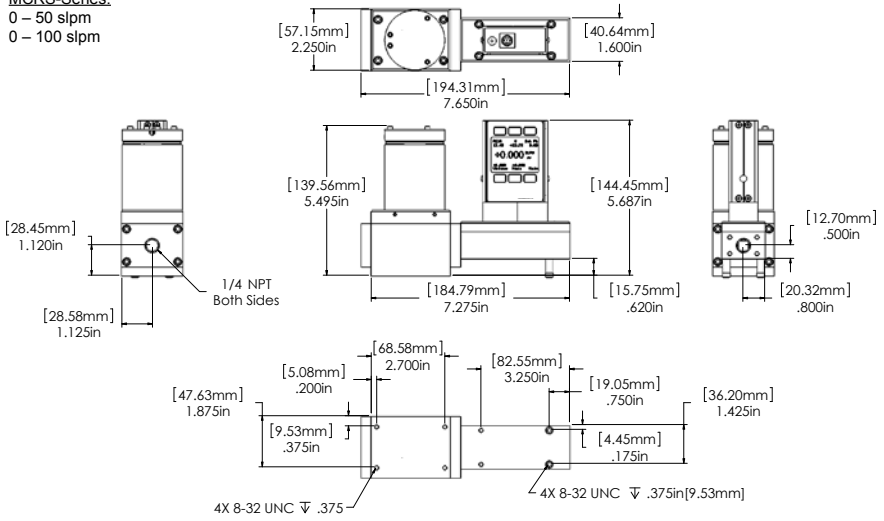

MCRS 50 slpm to 100 slpm approximate weight: 9.0 lb.

**MCRS-Series:**

0 – 250 slpm

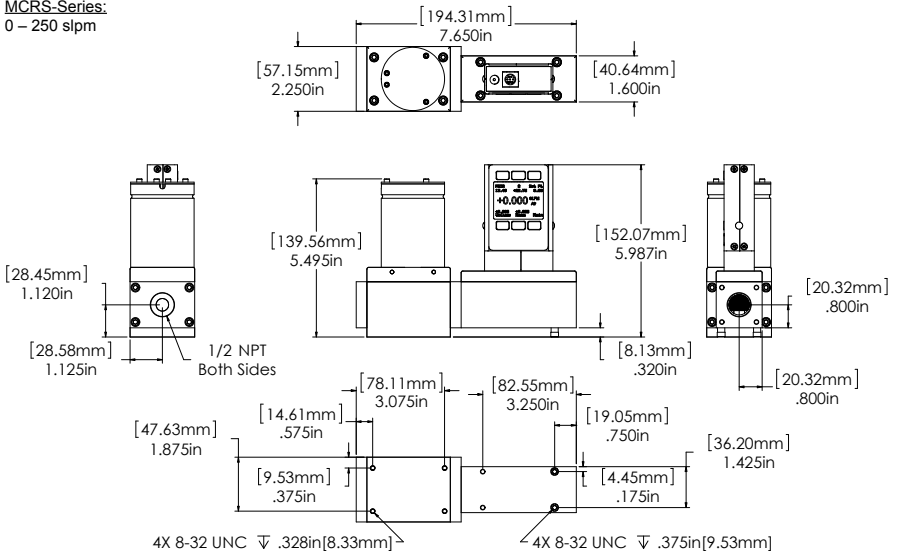

MCRS 250 slpm approximate weight: 9.0 lb.



**MCRS-Series:**  
0 – 3000 slpm

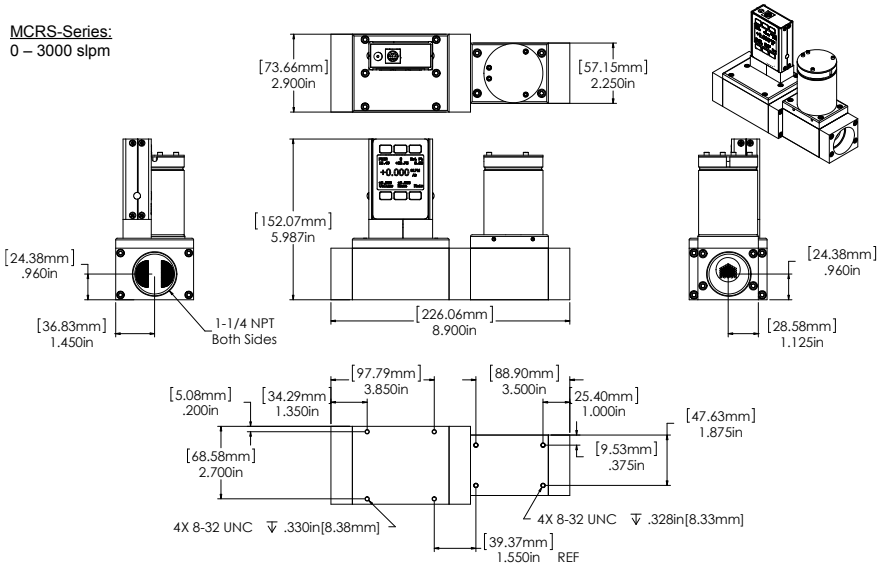

MCRS 3000 slpm approximate weight: 12.0 lb.

## Technical Data for PROFIBUS Meters, Gauges and Controllers

**NOTICE:** The following specifications are applicable to MC-Series PROFIBUS enabled meters, gauges and controllers only.

All other operating specifications are shown in the Technical Data page for standard MC-Series instruments.

All standard device features and functions are available and operate in accordance with the standard MC-Series device operating manual provided with the device.

| Specification                | Meter or Gauge               | Small Valve Controller         | Large Valve Controller | Description |
|------------------------------|------------------------------|--------------------------------|------------------------|-------------|
| Input /Output Signal Digital |                              |                                |                        | PROFIBUS DP |
| Electrical Connections       | DB9                          |                                |                        |             |
| Supply Voltage:              | 7 to 30 Vdc                  | 12 to 30 Vdc                   | 24 to 30 Vdc           |             |
| Supply Current               | 80mA @ 12Vdc<br>65mA @ 24Vdc | 295mA @ 12Vdc<br>280mA @ 24Vdc | 780mA @ 24Vdc          |             |

### Power and Signal Connections:

Connect to the device using two DB9 connectors. The female top connection is PROFIBUS.

The male connection on the side is power and RS-232 or RS-485.

Pin out diagrams for all PROFIBUS enabled MC-Series devices are shown:

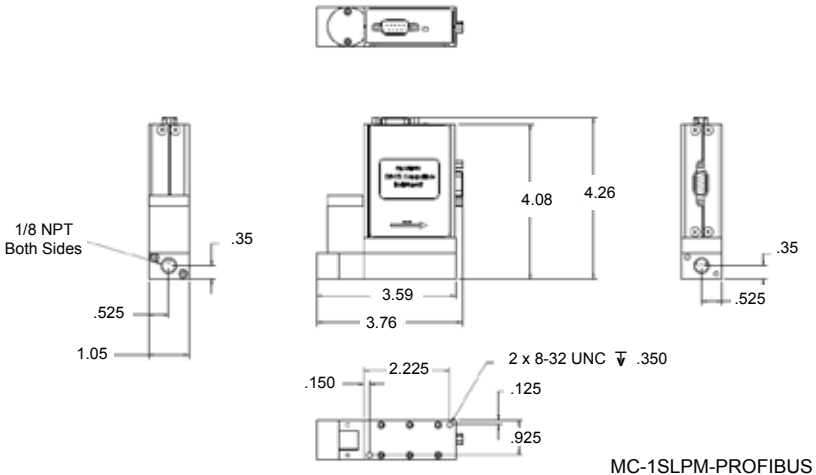
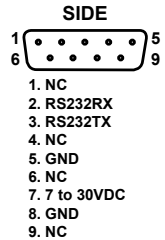
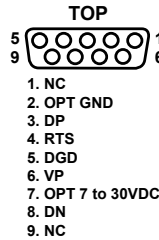

PROFIBUS MC1SLPM shown to provide PROFIBUS connector dimensions only. Flow body and valve dimensions will vary with range. Please see the device specifications for complete dimensions.

PROFIBUS units do not have a display screen.

# Eight Pin Mini-DIN Connector Pin-Outs

If your instrument was ordered with the standard Eight Pin Mini-DIN connection, please be sure to reference the following pin-out diagram.

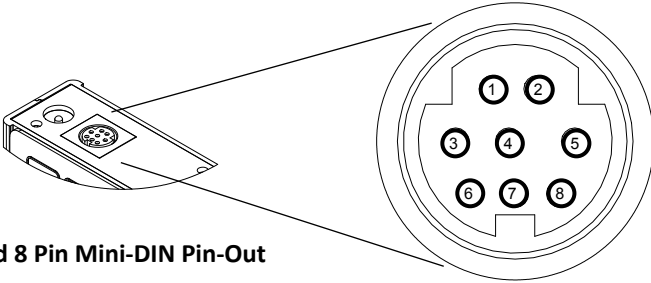

Standard 8 Pin Mini-DIN Pin-Out

| Pin | Function   | Mini-DIN cable color |
|-----|--|----------------------|
| 1   | Inactive (or optional 4-20mA Primary Output Signal)  | Black                |
| 2   | Static 5.12 Vdc [or optional Secondary Analog Output (4-20mA, 5Vdc, 10Vdc) or Basic Alarm] | Brown                |
| 3   | Serial RS-232RX / RS-485(-) Input Signal (receive)   | Red                  |
| 4   | Meters/Gauges = Remote Tare (Ground to Tare)<br>Controllers = Analog Set-Point Input       | Orange               |
| 5   | Serial RS-232TX / RS-485(+) Output Signal (send)   | Yellow               |
| 6   | 0-5 Vdc (or optional 0-10 Vdc) Output Signal   | Green                |
| 7   | Power In (as described above)  | Blue                 |
| 8   | Ground (common for power, digital communications, analog signals and alarms)               | Purple               |

**Note:** The above pin-out is applicable to all the flow meters and controllers with the Mini-DIN connector. The availability of different output signals depends on the options ordered. Optional configurations are noted on the unit's calibration sheet.

## Locking Industrial Connector Pin-Outs

If your instrument was ordered with a Six Pin Locking Industrial connection, please be sure to reference the following pin-out diagram.

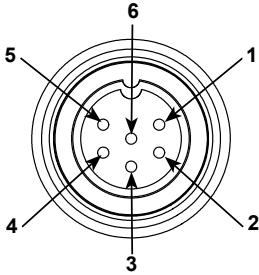

**Male Connector: Cable**

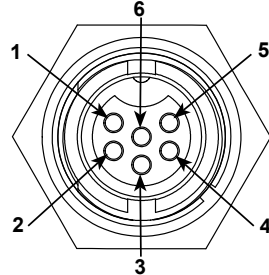

**Female Connector: Device**

| Pin | Function   |
|-----|--|
| 1   | Power In ( + )   |
| 2   | RS-232TX / RS-485(+)   |
| 3   | RS-232RX / RS-485(-)   |
| 4   | Meters/Gauges = Remote Tare (Ground to Tare)<br>Controllers = Analog Set-Point Input |
| 5   | Ground (common for power, communications and signals)                                |
| 6   | Signal Out (Voltage or Current as ordered)   |



The above pin-out is applicable to all the flow meters and controllers ordered with the industrial connector. The availability of different output signals depends on the flow meter options ordered.



If your instrument was ordered with a DB9 connection, be sure to check the Calibration Label on the device and reference the appropriate pin-out diagram.

## Standard DB9 Pin-out

The following pin-out chart describes the safest and generally compatible arrangement when connecting a non-MC-Series DB9 wire to a DB9 equipped MC-Series. Not all features may be available between brands, but the common denominators are featured in our DB9 offerings, along with some options for customization.

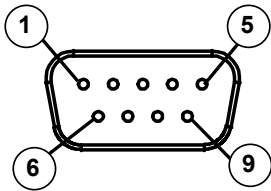

Male Connector Front View

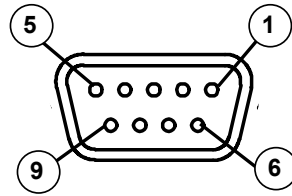

Female Connector Front View

| Pin | Function   |
|-----|--|
| 1   | Not Connected (4-20mA analog output signal optional)   |
| 2   | 5.12 Vdc or (secondary analog output (4-20mA, 5Vdc, 10Vdc or alarm optional)                               |
| 3   | Serial RS-232RX or RS-485(-)   |
| 4   | Analog Input Signal [4-20mA, 5Vdc, or 10Vdc] (short to ground for remote tare function on non-controllers) |
| 5   | Serial RS-232TX or RS-485(+)   |
| 6   | 0-5 Vdc Output Signal (or 0-10 Vdc optional)   |
| 7   | Power In (+Vdc)  |
| 8   | Ground (common for power, digital communications, analog signals and alarms)                               |
| 9   | Ground (common for power, digital communications, analog signals and alarms)                               |

**Note:** The above pin-out is applicable to all the flow meters and controllers with the DB9 connector. The availability of different output signals depends on the options ordered. Optional configurations are noted on the unit's calibration sheet.



**Do not connect RS-485 to RS-232 units or cables. Damage will occur! Check part number or contact factory to verify RS-485 functionality.**



Due to variance in cable manufacturing, please identify proper wiring/pins via continuity check & color when using blunt cut multi-strand cables.



If your instrument was ordered with a DB9 connection, be sure to check the Calibration Label on the device and reference the appropriate pin-out diagram.

## DB9A / DB9K Pin-out

The following pin-out chart describes the safest and generally compatible arrangement when connecting a non-MC-Series DB9 wire to a **DB9A** or **DB9K** equipped MC-Series. Not all features may be available between brands, but the common denominators are featured in our DB9A or DB9K offerings, along with some options for customization.

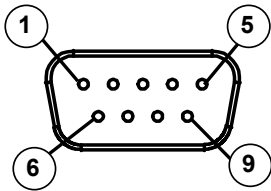

**Male Connector Front View**

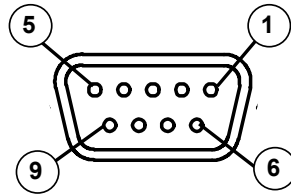

**Female Connector Front View**

| Pin | Function   |
|-----|--|
| 1   | Not Connected  |
| 2   | 0-5 Vdc Output Signal (or 0-10 Vdc optional)   |
| 3   | Power In (+Vdc)  |
| 4   | Ground (common for power, digital communications, analog signals and alarms)                               |
| 5   | Serial RS-232TX or RS-485 (+)  |
| 6   | Analog Input Signal [4-20mA, 5Vdc, or 10Vdc] (short to ground for remote tare function on non-controllers) |
| 7   | Ground (common for power, digital communications, analog signals and alarms)                               |
| 8   | Ground (common for power, digital communications, analog signals and alarms)                               |
| 9   | Serial RS-232RX or RS-485 (-)  |

**Note:** The above pin-out is applicable to all the flow meters and controllers with the **DB9A** or **DB9K** connector. The availability of different output signals depends on the options ordered. Optional configurations are noted on the unit's calibration sheet.



**Do not connect RS-485 to RS-232 units or cables. Damage will occur! Check part number or contact factory to verify RS-485 functionality.**



Due to variance in cable manufacturing, please identify proper wiring/pins via continuity check & color when using blunt cut multi-strand cables.



If your instrument was ordered with a DB9 connection, be sure to check the Calibration Label on the device and reference the appropriate pin-out diagram.

## DB9N Pin-out

The following pin-out chart describes the safest and generally compatible arrangement when connecting a non-M-Series DB9 wire to a **DB9N** equipped M-Series. Not all features may be available between brands, but the common denominators are featured in our DB9N offerings, along with some options for customization.

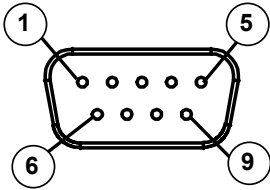

**Male Connector Front View**

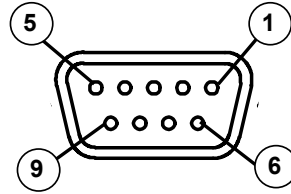

**Female Connector Front View**

| Pin  | Function   |
|--|--|
| 1  | Power In (+Vdc)  |
| 2  | Analog Input Signal [4-20mA, 5Vdc, or 10Vdc] (short to ground for remote tare function on non-controllers) |
| 3  | 0-5 Vdc Output Signal (or 0-10 Vdc optional)   |
| 4  | Not Connected  |
| 5  | Ground (common for power, digital communications, analog signals and alarms)                               |
| 6  | Ground (common for power, digital communications, analog signals and alarms)                               |
| 7  | Serial RS-232RX or RS-485 (-)  |
| 8  | Serial RS-232TX or RS-485 (+)  |
| 9  | Not Connected  |
| <p><b>Note:</b> The above pin-out is applicable to all the flow meters and controllers with the <b>DB9N</b> connector. The availability of different output signals depends on the options ordered. Optional configurations are noted on the unit's calibration sheet.</p> |  |



**Do not connect RS-485 to RS-232 units or cables. Damage will occur! Check part number or contact factory to verify RS-485 functionality.**



Due to variance in cable manufacturing, please identify proper wiring/pins via continuity check & color when using blunt cut multi-strand cables.



If your instrument was ordered with a DB9 connection, be sure to check the Calibration Label on the device and reference the appropriate pin-out diagram.

## DB9R Pin-out

The following pin-out chart describes the safest and generally compatible arrangement when connecting a non-M-Series DB9 wire to a **DB9R** equipped M-Series. Not all features may be available between brands, but the common denominators are featured in our DB9R offerings, along with some options for customization.

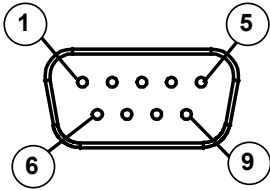

**Male Connector Front View**

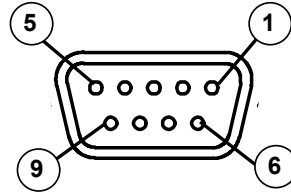

**Female Connector Front View**

| Pin | Function   |
|-----|--|
| 1   | Serial RS-232TX or RS-485 (+)  |
| 2   | 0-5 Vdc Output Signal (or 0-10 Vdc optional)   |
| 3   | Analog Input Signal [4-20mA, 5Vdc, or 10Vdc] (short to ground for remote tare function on non-controllers) |
| 4   | Ground (common for power, digital communications, analog signals and alarms)                               |
| 5   | Not Connected  |
| 6   | Serial RS-232RX or RS-485 (-)  |
| 7   | Power In (+Vdc)  |
| 8   | Ground (common for power, digital communications, analog signals and alarms)                               |
| 9   | Ground (common for power, digital communications, analog signals and alarms)                               |

**Note:** The above pin-out is applicable to all the flow meters and controllers with the **DB9R** connector. The availability of different output signals depends on the options ordered. Optional configurations are noted on the unit's calibration sheet.



**Do not connect RS-485 to RS-232 units or cables. Damage will occur! Check part number or contact factory to verify RS-485 functionality.**



Due to variance in cable manufacturing, please identify proper wiring/pins via continuity check & color when using blunt cut multi-strand cables.



If your instrument was ordered with a DB9 connection, be sure to check the Calibration Label on the device and reference the appropriate pin-out diagram.

## DB9T Pin-out

The following pin-out chart describes the safest and generally compatible arrangement when connecting a non-M-Series DB9 wire to a **DB9T** equipped M-Series. Not all features may be available between brands, but the common denominators are featured in our DB9T offerings, along with some options for customization.

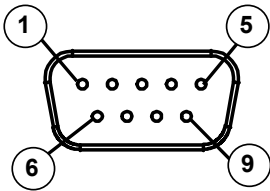

**Male Connector Front View**

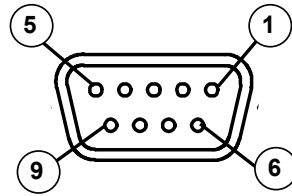

**Female Connector Front View**

| Pin  | Function   |
|--|--|
| 1  | Serial RS-232TX or RS-485 (+)  |
| 2  | 0-5 Vdc Output Signal (or 0-10 Vdc optional)   |
| 3  | Power In (+Vdc)  |
| 4  | Ground (common for power, digital communications, analog signals and alarms)                               |
| 5  | Not Connected  |
| 6  | Analog Input Signal [4-20mA, 5Vdc, or 10Vdc] (short to ground for remote tare function on non-controllers) |
| 7  | Ground (common for power, digital communications, analog signals and alarms)                               |
| 8  | Ground (common for power, digital communications, analog signals and alarms)                               |
| 9  | Serial RS-232RX or RS-485 (-)  |
| <p><b>Note:</b> The above pin-out is applicable to all the flow meters and controllers with the <b>DB9T</b> connector. The availability of different output signals depends on the options ordered. Optional configurations are noted on the unit's calibration sheet.</p> |  |



**Do not connect RS-485 to RS-232 units or cables. Damage will occur! Check part number or contact factory to verify RS-485 functionality.**



Due to variance in cable manufacturing, please identify proper wiring/pins via continuity check & color when using blunt cut multi-strand cables.

 If your instrument was ordered with a DB9 connection, be sure to check the Calibration Label on the device and reference the appropriate pin-out diagram.

## DB9U Pin-out

The following pin-out chart describes the safest and generally compatible arrangement when connecting a non-M-Series DB9 wire to a **DB9U** equipped M-Series. Not all features may be available between brands, but the common denominators are featured in our DB9U offerings, along with some options for customization.

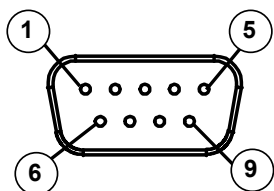

**Male Connector Front View**

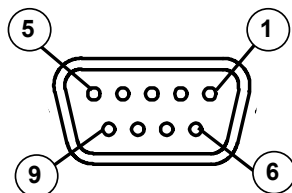

**Female Connector Front View**

| Pin  | Function   |
|--|--|
| 1  | Serial RS-232RX or RS-485(-)   |
| 2  | 0-5 Vdc Output Signal (or 0-10 Vdc optional)   |
| 3  | Power In (+Vdc)  |
| 4  | Ground (common for power, digital communications, analog signals and alarms)                               |
| 5  | Not Connected  |
| 6  | Analog Input Signal [4-20mA, 5Vdc, or 10Vdc] (short to ground for remote tare function on non-controllers) |
| 7  | Ground (common for power, digital communications, analog signals and alarms)                               |
| 8  | Ground (common for power, digital communications, analog signals and alarms)                               |
| 9  | Serial RS-232TX or RS-485(+)   |
| <p><b>Note:</b> The above pin-out is applicable to all the flow meters and controllers with the <b>DB9U</b> connector. The availability of different output signals depends on the options ordered. Optional configurations are noted on the unit's calibration sheet.</p> |  |



**Do not connect RS-485 to RS-232 units or cables. Damage will occur! Check part number or contact factory to verify RS-485 functionality.**



Due to variance in cable manufacturing, please identify proper wiring/pins via continuity check & color when using blunt cut multi-strand cables.

# DB15 Pin-Outs

If your instrument was ordered with a DB15 connection, be sure to check the Calibration Label on the device and reference the appropriate pin-out diagram.

The following pin-out chart describes the safest and generally compatible arrangement when connecting a non-M-Series DB15 wire to a **DB15** equipped M-Series. Not all features may be available between brands, but the common denominators are featured in our DB15 offerings, along with some options for customization.

## DB15 – Pin-Out Standard Style

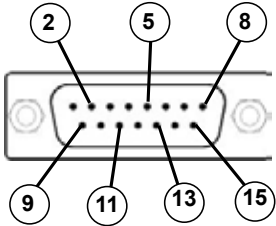

Male Connector Front View

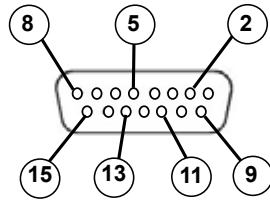

Female Connector Front View

| Pin Number | Function   |
|------------|--|
| 1          | Ground   |
| 2          | Primary Analog Signal Output   |
| 3          | Ground   |
| 4          | N/C  |
| 5          | Power Supply (+Vdc)  |
| 6          | N/C  |
| 7          | N/C  |
| 8          | Analog Tare (meters — when grounded)<br>Analog Set-Point Input (controllers) |
| 9          | Power Supply Common  |
| 10         | Ground   |
| 11         | Secondary Analog Signal Output / fixed 5.12Vdc                               |
| 12         | N/C  |
| 13         | RS-232 RX (receive) or RS-485 –  |
| 14         | Ground   |
| 15         | RS-232 TX (send) or RS-485 +   |

Check your device's calibration certificate and user manual for the actual electrical input/output requirements, as all instruments are custom configured to some extent.

**NOTE:** Pins 1, 3, 9, 10 and 14 are connected together inside of the device and are common grounding points.

**N/C** = Not Connected/Open (can be used for custom pin assignments – please consult factory).

# DB15 Pin-Outs

If your instrument was ordered with a DB15 connection, be sure to check the Calibration Label on the device and reference the appropriate pin-out diagram.

The following pin-out chart describes the safest and generally compatible arrangement when connecting a non-M-Series DB15 wire to a **DB15A** equipped M-Series. Not all features may be available between brands, but the common denominators are featured in our DB15 offerings, along with some options for customization.

## DB15A – Pin-Out “Aalborg XFM” Style

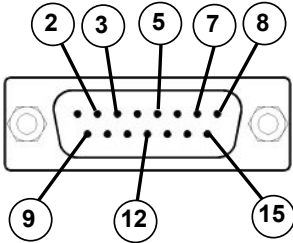

Male Connector Front View

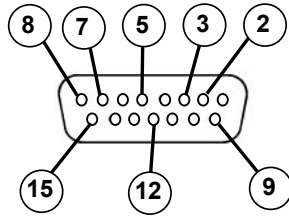

Female Connector Front View

| Pin Number | Function   |
|------------|--|
| 1          | Ground   |
| 2          | Primary Analog Signal Output   |
| 3          | Analog Tare (meters — when grounded)*<br>Analog Set-Point Input (controllers)* |
| 4          | Ground   |
| 5          | Power Supply Common  |
| 6          | Ground   |
| 7          | Power Supply (+Vdc)  |
| 8          | RS-232 Tx (send) / RS-485 –  |
| 9          | Ground   |
| 10         | N/C  |
| 11         | N/C  |
| 12         | Secondary Analog Signal Output / fixed 5.12Vdc*                                |
| 13         | N/C  |
| 14         | N/C  |
| 15         | RS-232 Rx (receive) / RS-485 +   |

Check your device's calibration certificate and user manual for the actual electrical input/output requirements, as all instruments are custom configured to some extent.

\* Added to allow for full use of features on M-Series devices, may not be present on host wiring

**NOTE:** Pins 1, 4, 5, 6 and 9 are connected together inside of the device and are common grounding points.

**N/C** = Not Connected/Open (can be used for custom pin assignments – please consult factory).

# DB15 Pin-Outs

If your instrument was ordered with a DB15 connection, be sure to check the Calibration Label on the device and reference the appropriate pin-out diagram.

The following pin-out chart describes the safest and generally compatible arrangement when connecting a non-M-Series DB15 wire to a **DB15B** equipped M-Series. Not all features may be available between brands, but the common denominators are featured in our DB15 offerings, along with some options for customization.

## DB15B – Pin-Out “Brooks” Style

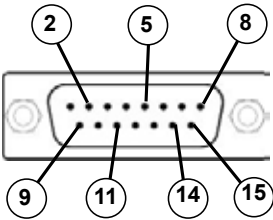

Male Connector Front View

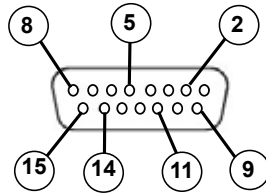

Female Connector Front View

| Pin Number | Function   |
|------------|--|
| 1          | Ground   |
| 2          | Primary Analog Signal Output   |
| 3          | N/C  |
| 4          | N/C  |
| 5          | Power Supply (+Vdc)  |
| 6          | N/C  |
| 7          | N/C  |
| 8          | Analog Tare (meters — when grounded)*<br>Analog Set-Point Input (controllers)* |
| 9          | Power Supply Common  |
| 10         | Ground   |
| 11         | Secondary Analog Signal Output / fixed 5.12Vdc                                 |
| 12         | N/C  |
| 13         | N/C  |
| 14         | RS-232 RX (receive) or RS-485 —*   |
| 15         | RS-232 TX (send) or RS-485 +*  |

Check your device's calibration certificate and user manual for the actual electrical input/output requirements, as all instruments are custom configured to some extent.

**NOTE:** Pins 1, 9, and 10 are connected together inside of the device and are common grounding points.

**N/C** = Not Connected/Open (can be used for custom pin assignments – please consult factory).

\* Added to allow for full use of features on M-Series devices, may not be present on host wiring

# DB15 Pin-Outs

If your instrument was ordered with a DB15 connection, be sure to check the Calibration Label on the device and reference the appropriate pin-out diagram.

The following pin-out chart describes the safest and generally compatible arrangement when connecting a non-M-Series DB15 wire to a **DB15K** equipped M-Series. Not all features may be available between brands, but the common denominators are featured in our DB15 offerings, along with some options for customization.

## DB15K – Pin-Out “MKS” Style

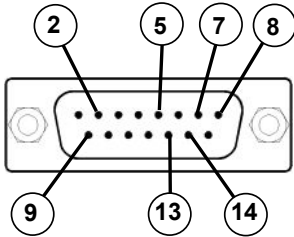

Male Connector Front View

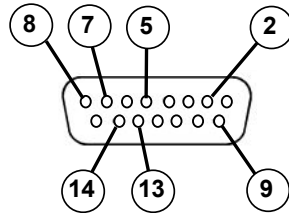

Female Connector Front View

| Pin Number | Function   |
|------------|--|
| 1          | N/C  |
| 2          | Primary Analog Signal Output   |
| 3          | N/C  |
| 4          | N/C  |
| 5          | Power Supply Common  |
| 6          | N/C  |
| 7          | Power Supply (+Vdc)  |
| 8          | Analog Tare (meters — when grounded)<br>Analog Set-Point Input (controllers) |
| 9          | Secondary Analog Signal Output / fixed 5.12Vdc *                             |
| 10         | N/C  |
| 11         | Ground   |
| 12         | Ground   |
| 13         | RS-232 RX (receive) or RS-485 – *  |
| 14         | RS-232 TX (send) or RS-485 + *   |
| 15         | Ground   |

Check your device's calibration certificate and user manual for the actual electrical input/output requirements, as all instruments are custom configured to some extent.

**NOTE:** Pins 5, 11, 12 and 15 are connected together inside of the device and are common grounding points.

**N/C** = Not Connected/Open (can be used for custom pin assignments – please consult factory).

\* Added to allow for full use of features on M-Series devices, may not be present on host wiring.

# DB15 Pin-Outs

If your instrument was ordered with a DB15 connection, be sure to check the Calibration Label on the device and reference the appropriate pin-out diagram.

The following pin-out chart describes the safest and generally compatible arrangement when connecting a non-M-Series DB15 wire to a **DB15H** equipped M-Series. Not all features may be available between brands, but the common denominators are featured in our DB15 offerings, along with some options for customization.

## DB15H – Pin-Out “Hastings H” Style

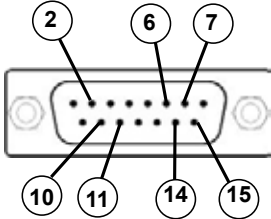

Male Connector Front View

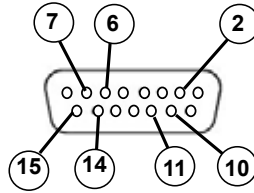

Female Connector Front View

| Pin Number | Function   |
|------------|--|
| 1          | N/C  |
| 2          | RS-232 RX (receive) or RS-485 – *  |
| 3          | N/C  |
| 4          | N/C  |
| 5          | Ground   |
| 6          | Primary Analog Signal Output   |
| 7          | Power Supply Common  |
| 8          | N/C  |
| 9          | N/C  |
| 10         | Secondary Analog Signal Output / fixed 5.12Vdc *                             |
| 11         | Power Supply (+Vdc)  |
| 12         | Ground   |
| 13         | N/C  |
| 14         | Analog Tare (meters — when grounded)<br>Analog Set-Point Input (controllers) |
| 15         | RS-232 TX (send) or RS-485 + *   |

Check your device's calibration certificate and user manual for the actual electrical input/output requirements, as all instruments are custom configured to some extent.

**NOTE:** Pins 5, 7 and 12 are connected together inside of the device and are common grounding points.

**N/C** = Not Connected/Open (can be used for custom pin assignments – please consult factory).

\* Added to allow for full use of features on M-Series devices, may not be present on host wiring.

# DB15 Pin-Outs

If your instrument was ordered with a DB15 connection, be sure to check the Calibration Label on the device and reference the appropriate pin-out diagram.

The following pin-out chart describes the safest and generally compatible arrangement when connecting a non-M-Series DB15 wire to a **DB150** equipped M-Series. Not all features may be available between brands, but the common denominators are featured in our DB15 offerings, along with some options for customization.

## DB150 – Pin-Out "Brooks" variant

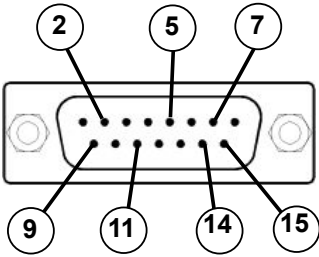

Male Connector Front View

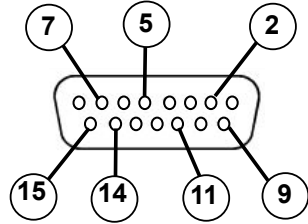

Female Connector Front View

| Pin Number | Function   |
|------------|--|
| 1          | Ground   |
| 2          | N/C  |
| 3          | N/C  |
| 4          | Primary Analog Signal Output   |
| 5          | Power Supply (+Vdc)  |
| 6          | N/C  |
| 7          | Analog Tare (meters — when grounded)*<br>Analog Set-Point Input (controllers)* |
| 8          | N/C  |
| 9          | Power Supply Common  |
| 10         | Ground   |
| 11         | Secondary Analog Signal Output / fixed 5.12Vdc                                 |
| 12         | N/C  |
| 13         | N/C  |
| 14         | RS-232 RX (receive) or RS-485 -*   |
| 15         | RS-232 TX (send) or RS-485 +*  |

Check your device's calibration certificate and user manual for the actual electrical input/output requirements, as all instruments are custom configured to some extent.

**NOTE:** Pins 1, 9, and 10 are connected together inside of the device and are common grounding points.

**N/C** = Not Connected/Open (can be used for custom pin assignments – please consult factory).

\* Added to allow for full use of features on M-Series devices, may not be present on host wiring

# DB15 Pin-Outs

If your instrument was ordered with a DB15 connection, be sure to check the Calibration Label on the device and reference the appropriate pin-out diagram.

The following pin-out chart describes the safest and generally compatible arrangement when connecting a non-M-Series DB15 wire to a **DB15S** equipped M-Series. Not all features may be available between brands, but the common denominators are featured in our DB15 offerings, along with some options for customization.

## DB15S – Pin-Out “Sierra” Style

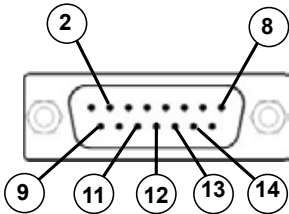

Male Connector Front View

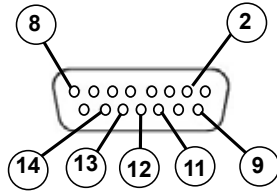

Female Connector Front View

| Pin Number | Function   |
|------------|--|
| 1          | Ground   |
| 2          | Primary Analog Signal Output   |
| 3          | N/C  |
| 4          | N/C  |
| 5          | Ground   |
| 6          | N/C  |
| 7          | N/C  |
| 8          | Analog Tare (meters — when grounded)<br>Analog Set-Point Input (controllers) |
| 9          | Power Supply Common  |
| 10         | Ground   |
| 11         | Secondary Analog Signal Output / fixed 5.12Vdc *                             |
| 12         | RS-232 RX (receive) or RS-485 - *  |
| 13         | Power Supply (+Vdc)  |
| 14         | RS-232 TX (send) or RS-485 + *   |
| 15         | Ground   |

Check your device's calibration certificate and user manual for the actual electrical input/output requirements, as all instruments are custom configured to some extent.

**NOTE:** Pins 1, 5, 9, 10 and 15 are connected together inside of the device and are common grounding points.

**N/C** = Not Connected/Open (can be used for custom pin assignments – please consult factory).

\* Added to allow for full use of features on M-Series devices, may not be present on host wiring.

**Additional Information for  
CSA and ATEX Approved Devices**



**EEx nA IIC T4**

**Class I, Div. 2 Group A, B, C and D T4**

**24 Vdc, 0.800A max**

**Class I, Zone 2 AEx nA IIC T4**



**WARNINGS:**

**EXPLOSION HAZARD** – DO NOT DISCONNECT WHILE CIRCUIT IS LIVE UNLESS AREA IS KNOWN TO BE NON-HAZARDOUS.

**EXPLOSION HAZARD** – SUBSTITUTION OF COMPONENTS MAY IMPAIR SUITABILITY FOR CLASS I, DIVISION 2.

CSA / ATEX approved devices are equipped with either a locking six pin industrial connector (IC), locking D-sub 15 pin connector (DB15) or locking D-sub 9 pin connector (DB9). Please see pages 85 - 98 for the correct power and signal connections for each type of connector.

**See the following page for special conditions regarding the use of these units!**

**USE of instruments (L, LC, LCR, M, MW, MS, MC, MCW, MCS, MCR, MCRW, MCRS, P, PS, PC, PCS, PCR and PCRS product families only) in Class 1 Division 2 applications.**



CSA certifies the use of this product for general use as well as use in hazardous locations as defined by Class 1 Division 2 Group A, B, C and D T4.

**CSA certification is indicated by the product label as shown below and not by the statements in this, or any accompanying documentation.**

**Special Conditions:**

To comply with CSA certification the following information is included in the product literature:

- When equipment is properly labeled, it is suitable in Class I, Division 2, Group A, B, C and D, T4
  - Tamb. -40°C to +50°C
- Electrical Rating 24Vdc, 0.800A max
- Instruments shall be powered by a CSA certified, UL listed, Class II external power supply suitable for the application
- Instruments shall be housed in an enclosure with a minimum IP54 rating or location providing equivalent protection
- Instrument's final approval shall be provided by the local authority having jurisdiction

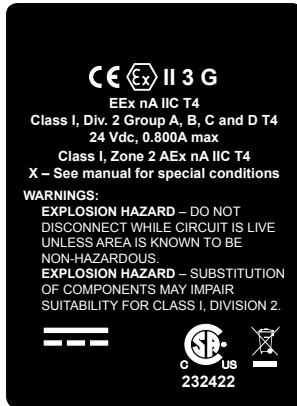

**USE of instruments (L, LC, LCR, M, MS, MC, MCS, MCR, MCRS, P, PS, PC, PCS, PCR and PCRS product families only) in applications requiring ATEX Certification.**



Properly labeled instruments comply to the following ATEX standard:



II 3 G EEx nA IIC T4 (-40°C ≤ Ta ≤ +50°C)

The examination certificate was issued by the CSA in accordance with accepted practices and procedures. This confirms compliance with the European ATEX Directive or Group II Category 3G equipment.

**ATEX certification is indicated by the product label as shown above and not by the statements in this, or any accompanying documentation.**

**Special Conditions:**

- Properly labeled equipment is only certified for use in ambient temperatures in the range of -40°C to +50°C only
- Electrical Rating 24Vdc, 0.800A max
- Instruments shall be powered by a CSA certified, UL listed, Class II external power supply suitable for the application
- Instruments shall be housed in an enclosure with a minimum IP54 rating or location providing equivalent protection
- Instrument's final approval shall be provided by the local authority having jurisdiction



**Serial Number:** \_\_\_\_\_

**Model Number:** \_\_\_\_\_