



Precision Water Flow Meter and Water Flow Controller Operating Manual

Notice: The manufacturer reserves the right to make any changes and improvements to the products described in this manual at any time and without notice. This manual is copyrighted. This document may not, in whole or in part, be copied, reproduced, translated, or converted to any electronic medium or machine readable form, for commercial purposes, without prior written consent from the copyright holder.

Note: Although we provide assistance on our products both personally and through our literature, it is the complete responsibility of the user to determine the suitability of any product to their application.

The manufacturer does not warrant or assume responsibility for the use of its products in life support applications or systems.

Warranty

This product is warranted to the original purchaser for a period of one year from the date of purchase to be free of defects in material or workmanship. Under this warranty the product will be repaired or replaced at manufacturer's option, without charge for parts or labor when the product is carried or shipped prepaid to the factory together with proof of purchase. This warranty does not apply to cosmetic items, nor to products that are damaged, defaced or otherwise misused or subjected to abnormal use. See "Application" under the Installation section. Where consistent with state law, the manufacturer shall not be liable for consequential economic, property, or personal injury damages. The manufacturer does not warrant or assume responsibility for the use of its products in life support applications or systems.

Conformity / Supplemental Information:

The product complies with the requirements of the Low Voltage Directive 2006/95/EC and the EMC Directive 2004/108/EC and carries the CE Marking accordingly. Contact the manufacturer for more information.

Notes for Using Laminar Water Flow Devices

- ▶ **USE ONLY PURE, CLEAN DI OR DISTILLED WATER IN THIS DEVICE.**
- ▶ **DO NOT** use tap water or water with any biological components, minerals or oils. Any of these substances will affect the viscosity of the water (creating flow measurement inaccuracies). More importantly, ***these impurities will quickly build up in the laminar flow zone, cause corrosion, and render the measuring capabilities of the device useless. Pure DI water itself is corrosive to some extent, but it is the contaminants in your system that will be most detrimental to your laminar liquid water flow meter.***
- ▶ **If you cannot meet the requirement of pure water, then do not use the laminar water flow device in your application.** Damage caused by impurity build up is not covered by the warranty.
- ▶ Please read the operating manual that accompanied your device. Keep the manual for future reference.
- ▶ When first using the laminar water meter or controller for the day, please take the following precautions:
 1. Apply your source pressure (approx. 20-30 psig for best results) to the device with the downstream flow blocked off.
 2. Then slightly open both bleed ports (DO NOT completely remove the screws) and allow any trapped air to escape. Allow some flow and let water pass through while bleeding (if the unit is a controller be sure to give it at least a 50% set-point). See *page 10* of the manual for more information regarding bleed ports and bleeding.
 3. Try not to get any water in-between the black electronics case and the stainless steel flow body. Wipe up any excess water around these seams.
 4. Tighten up both bleed screws, and then block the downstream water flow again. Visually verify zero flow through.
 5. Now you can safely tare (zero) a meter (*page 19*) using the tare button on the device, or in the case of a water flow controller, command the zero set-point (*page 28*) which will auto-tare the unit.
- ▶ Smooth and consistent source pressure is highly preferable, as any pulsing or fluctuation in water pressure will hydraulically couple to the differential pressure sensor, and the resultant flow reading will jump analogously.
- ▶ Please note that, depending on model and flow range, water flow meters have an inherent internal pressure drop higher than that of standard gas flow meters of similar flow range. The minimum water device pressure drop is 2 psig, going all the way to 20 psig drop in certain models. ***Your source input pressure must meet or exceed this specification, in addition to any back pressure you may have on the downstream end of your process.*** Please see pages 49 and 52 of the manual.

Please contact your dealer if you have any questions.

Thank you for purchasing an L-Series Water Flow Meter or LC or LCR Water Flow Controller.

Please take the time to find and read the information contained in this manual. This will help to ensure that you get the best possible service from your instrument. This manual covers the following instruments:

L-Series Water Flow Meters

LC-Series Water Flow Controllers

LCR-Series Water Flow Controllers

This includes L, LC and LCR-Series devices labeled as approved for CSA Class 1 Div 2 and ATEX Class 1 Zone 2 hazardous environments. See pages 74 and 75 for Special Conditions regarding the use of CSA/ATEX labeled devices.

LB-Series Portable Water Meters

Note: All L-Series Portable Water Meters operate in accordance with the instructions found in this manual. Please see page 46 for information regarding portable use and recharge.



Please contact Your dealer if you have any questions regarding the use or operation of this device.

Many L-Series instruments are built for specific applications. Two instruments with the same flow range and part number may look and act quite differently depending upon the application the instrument was built for. Care should be taken when moving an instrument from one application to another.

TABLE OF CONTENTS	Page
GETTING STARTED	8
MOUNTING	9
PLUMBING	9
PRESSURE	10
BLEED PORTS	11
POWER AND SIGNAL CONNECTIONS	12
INPUT SIGNALS	13
Analog Input Signal	13
RS-232 / RS-485 Digital Input Signal	14
OUTPUT SIGNALS	15
RS-232 / RS-485 Digital Output Signal	15
Standard Voltage (0-5 Vdc) Output Signal	15
Optional 0-10 Vdc Output Signal	15
Optional Current (4-20 mA) Output Signal	15
Optional 2nd Analog Output Signal	15
Information for TFT (Color Display) Instruments	17
DISPLAYS AND MENUS L-Series Meters	18
MAIN	19
Line Absolute Pressure	19
Line Temperature	19
Tare	19
Volume Flow Rate	19
<i>Flashing Error Message</i>	19
SELECT MENU	20
COMMUNICATION SELECT	21
Unit ID	21
Baud	21
MISCELLANEOUS	22
MISC1	22
Zero Band	22
Pressure Averaging	22
Flow Averaging	22
LCD Contrast	22
MISC2	23
DIAG TEST	23
Rotate Display	23
DEVICE UNITS	24
MANUFACTURER DATA	24
DISPLAYS AND MENUS LC and LCR-Series Controllers	25
MAIN	26
SELECT MENU	27
CONTROL SET UP	28
Set-Point Source	28
Loop Variable	29
On / Off Auto-tare	29

TABLE OF CONTENTS	Page
PID Tuning	30
RS-232 or RS-485 Output and Input	32
Configuring HyperTerminal®	32
Streaming Mode	32
Tareing via RS-232 / RS-485	33
Sending a Set-point via RS-232 / RS-485	33
PID Tuning via RS-232 / RS-485	34
Changing from Streaming to Polling Mode	35
Collecting Data	36
Data Format	37
Sending a Simple Script File to HyperTerminal®	38
FLOW MEASUREMENT OPERATING PRINCIPLE	39
SUPPORTED UNITS	40
TROUBLESHOOTING	42
MAINTENANCE AND RECALIBRATION	43
FLOW CONVERSION TABLE	43
Option: Totalizing Mode	44
Batch Processing Mode – Controllers Only	45
Option: Portable Meters and Gauges	46
Pressure Menu for Portable Meters	47
Accessory: Multi-Drop Box	48
Accessory: Flow Vision™ SC	49
Accessory: Flow Vision™ MX	49
Accessories	50
L-Series Technical Specifications	52
LC and LCR-Series Specifications	55
PROFIBUS Technical Specifications	58
Eight Pin Mini-DIN Pin-Out	59
Locking Industrial Connector Pin-Out	60
DB9 Pin-Out Diagram	61
DB15 Pin-Out Diagrams	67
Information for CSA and ATEX Labeled Devices	74

GETTING STARTED

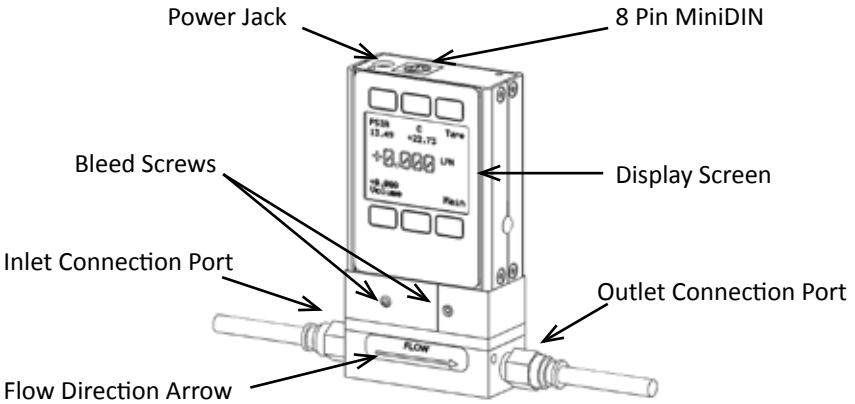

L Water Flow Meter shown with connection port fittings

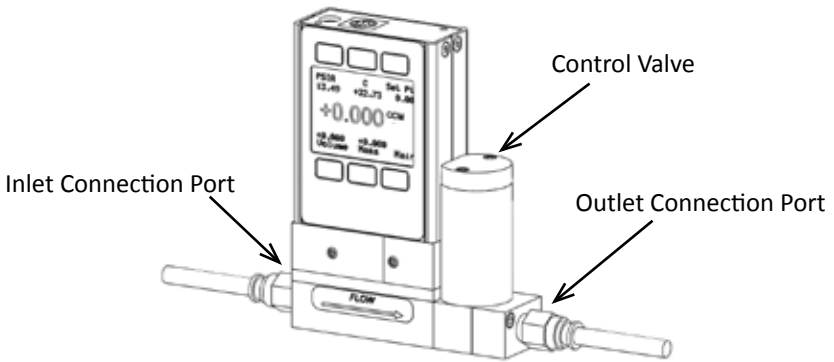

LC Water Flow Controller shown with the standard downstream valve and connection port fittings

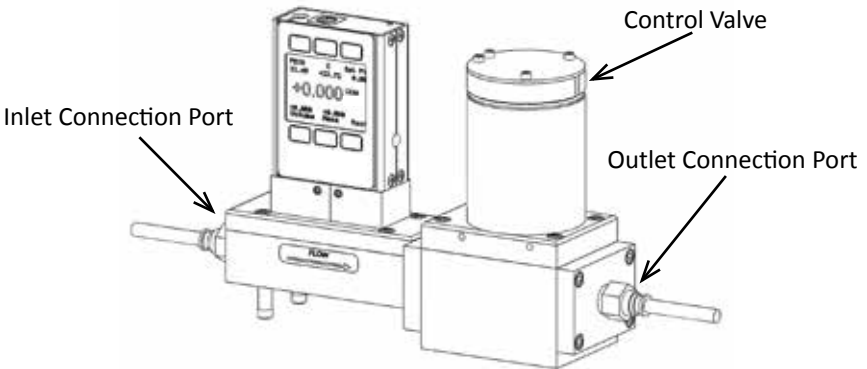

LCR Water Flow Controller shown with the standard downstream valve and connection port fittings

MOUNTING

All L-Series Meters and LC-Series Controllers have mounting holes for convenient mounting to flat panels. The sizes and dimensions for the mounting holes are shown on pages 52-57.

Meters are position insensitive and can be mounted in any orientation.

Small valve controllers (LC-Series) can usually be mounted in any position.

Large valve controllers (LCR-Series) should be mounted so that the valve cylinder is vertical. Mounting a large valve controller in another position increases the risk of leakage when the controller is being held closed by the spring force.

Note: For applications that may continuously introduce occasional air bubbles to the flow stream upstream of the device, the device may be mounted upside down to prevent the bubbles from becoming trapped in the differential pressure sensor ports.

 ***If the device has been installed upside down, avoid using the bleed screws as water may leak into the electronics housing causing permanent damage that is not covered under warranty!***

PLUMBING

 ***Your controller is shipped with plastic plugs fitted in the port openings. To lessen the chance of contaminating the flow stream do not remove these plugs until you are ready to install the device.***

Make sure that the water will flow in the direction indicated by the flow arrow.

Standard L-Series Meters and LC-Series Controllers have female inlet and outlet port connections. Welded VCR and other specialty fittings may have male ports.

The inlet and outlet port sizes (process connections) for different flow ranges are shown on pages 54-59.

Instruments with M5 (10-32) ports have O-ring face seals and require no sealant or tape. Do not use tape with welded or o-ring fittings.

For non M5 (10-32) ports use thread sealing Teflon® tape to prevent leakage around the port threads.

Do not wrap the first two threads. This will minimize the possibility of getting tape into the flow stream and flow body.

 ***Do not use pipe dopes or sealants on the process connections as these compounds can cause permanent damage to the controller should they get into the flow stream.***

When changing fittings, carefully clean any tape or debris from the port threads.

We recommend that a 20 micron filter be installed upstream of meter/controllers with full scale ranges of 100 ccm or less and a 40 micron filter be installed upstream of meter/controllers with full scale ranges above 100 ccm.

 ***Avoiding long runs of small diameter tubing upstream or downstream of the device will reduce water hammer.***

PRESSURE

Maximum operating line pressure is 100 psig (689 kPa). If the line pressure is higher than 100 psig (689 kPa), use a pressure regulator upstream from the flow controller to reduce the pressure to 100 psig (689 kPa) or less.

Although the meter's operation is uni-directional, reversing the flow direction will inflict no damage as long as the maximum specified limits are not exceeded. The differential pressure sensor utilized in this flow meter/controller is a very sensitive device capable of detecting minute differences in pressure.

Smooth and consistent source pressure is highly preferable, as any pulsing or fluctuation in water pressure will hydraulically couple to the differential pressure sensor, and the resultant flow reading will jump analogously.

Please note that, depending on model and flow range, water flow meters have an inherent internal pressure drop higher than that of standard gas flow meters of similar flow range. The minimum water device pressure drop is 2 psig, going all the way to 20 psig drop in certain models. Your source input pressure must meet or exceed this specification, in addition to any back pressure you may have on the downstream end of your process.



CAUTION! *EXCEEDING THE MAXIMUM SPECIFIED LINE PRESSURE MAY CAUSE PERMANENT DAMAGE TO THE SOLID-STATE DIFFERENTIAL PRESSURE TRANSDUCER.*

BLEED PORTS

L and LC-Series flow meters and controllers are equipped with bleed ports on the front to aid in the removal of air bubbles from the differential pressure sensor ports. The bleed ports consist of a threaded hole with an 8-32 nylon tipped screw. After installation or anytime it is suspected that air may be trapped in the sensor ports, bleed the ports as follows:



A small amount of water will leak from the device during this procedure. Take necessary precautions to prevent the leaking water from damaging anything around the unit, taking special care to avoid any live electrical devices or lines.

1. With the meter/controller installed and line pressure applied, gently loosen the upstream bleed port screw 1-2 turns or until water begins to leak from the threads. **DO NOT REMOVE THE SCREW** as the port is subject to line pressures and injury, equipment damage or loss of required parts may result!
2. Gently tap the flow body (a wooden or plastic screwdriver handle works well for this) to encourage air bubbles to exit the port.
3. Any air in the port will generally be removed as the water leaks out even though you may not see or hear it.
4. Gently tighten the screw until the leakage stops, taking care not to crush the nylon tip.

Repeat steps 1-4 with the second bleed port.

8-32 Nylon Tipped Bleed Screw
5/64 Hex Loosen to Bleed
DO NOT REMOVE!

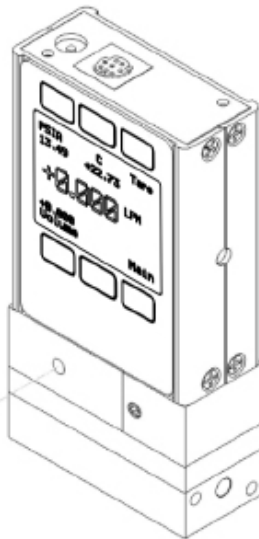

If your device is mounted in an inverted position avoid using the bleed screws as water may leak into the electronics housing causing permanent damage that is not covered under warranty!

POWER AND SIGNAL CONNECTIONS

Power can be supplied to your meter/controller through either the power jack (power jack not available on CSA/ATEX approved devices) or the 8 pin Mini-DIN connector.

An AC to DC adapter which converts line AC power to DC voltage and current as specified below is required to use the power jack.

A 2.1mm, positive center, 7-30 Vdc AC/DC adapter rated for at least 100 mA is required to use the adapter jack in a **L-Series meter**.

A 2.1mm, positive center, 12-30 Vdc AC/DC adapter rated for at least 250 mA is required to use the adapter jack in a **LC-Series controller**.

A 2.1mm, positive center, 24-30 Vdc AC/DC adapter rated for at least 750 mA is required to use the adapter jack in a **LCR-Series controller**.

NOTE: 4-20mA analog output requires at least 15 Vdc.

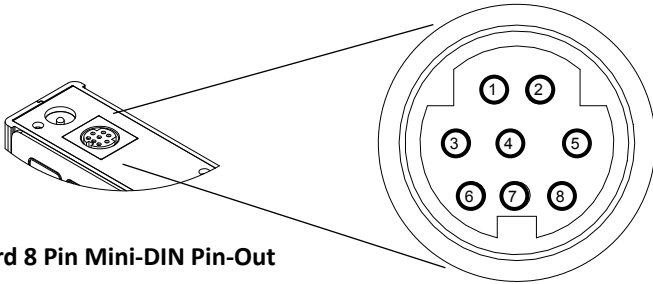

Standard 8 Pin Mini-DIN Pin-Out

Pin	Function	Mini-DIN cable color
1	Not Connected (or optional 4-20mA Primary Output Signal)	Black
2	Static 5.12 Vdc [or optional Secondary Analog Output (4-20mA, 5Vdc, 10Vdc) or Basic Alarm]	Brown
3	Serial RS-232RX / RS-485(-) Input Signal (receive)	Red
4	Meters/Gauges = Remote Tare (Ground to Tare) Controllers = Analog Set-Point Input	Orange
5	Serial RS-232TX / RS-485(+) Output Signal (send)	Yellow
6	0-5 Vdc (or optional 0-10 Vdc) Output Signal	Green
7	Power In (as described above)	Blue
8	Ground (common for power, communications and analog signals)	Purple

Note: The above pin-out is applicable to all the flow meters and controllers with the Mini-DIN connector. The availability of different output signals depends on the options ordered. Optional configurations are noted on the unit's calibration sheet.



CAUTION! Do NOT connect power to pins 1 through 6 as permanent damage can occur!



It is common to mistake Pin 2 (labeled 5.12 Vdc Output) as the standard 0-5 Vdc analog output signal. In fact Pin 2 is normally a constant 5.12 Vdc that reflects the system bus voltage and can be used as a source for the set-point signal.

For 6 Pin Locking Connector, DB9 and DB15 Pin-outs see pages 61 to 73.

For PROFIBUS Pin-outs see pages 59.

INPUT SIGNALS

Analog Input Signal

Apply analog input to Pin 4 as shown on page 12.

For 6 Pin Locking Connector, DB9 and DB15 Pin-outs see pages 61 to 73.

For PROFIBUS Pin-outs see pages 59.

Standard 0-5 Vdc is the standard analog input signal. Apply the 0-5 Vdc input signal to pin 4, with common ground on pin 8.

Optional 0-10 Vdc: If specified at time of order, a 0-10 Vdc input signal can be applied to pin 4, with common ground on pin 8.

Optional 4-20 mA: If specified at time of order, a 4-20 mA input signal can be applied to pin 4, with common ground on pin 8.

NOTE: This is a current sinking device. The receiving circuit is essentially a 250 ohm resistor to ground.

NOTE: 4-20mA output requires at least 15 Vdc power input.



CAUTION! DO NOT CONNECT THIS DEVICE TO "LOOP POWERED" SYSTEMS, AS THIS WILL DESTROY PORTIONS OF THE CIRCUITRY AND VOID THE WARRANTY. IF YOU MUST INTERFACE WITH EXISTING LOOP POWERED SYSTEMS, ALWAYS USE A SIGNAL ISOLATOR AND A SEPARATE POWER SUPPLY.

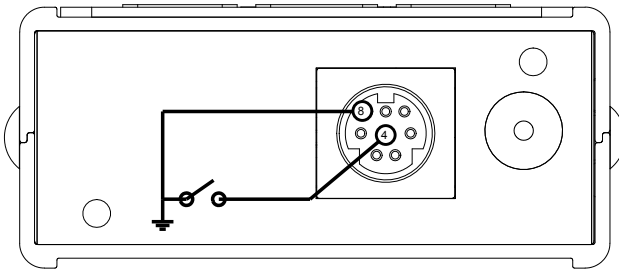

Gauges: A remote tare can be achieved by momentarily grounding pin 4 to tare.

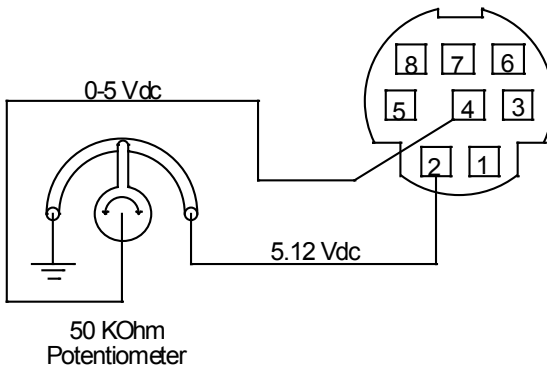

Controllers: A simple method for providing set-point to controllers

RS-232 / RS-485 Digital Input Signal

To use the RS-232 or RS-485 input signal, connect the RS-232 / RS-485 Output Signal (Pin 5), the RS-232 / RS-485 Input Signal (Pin 3), and Ground (Pin 8) to your computer serial port as shown below. (See page 32 for details on accessing RS-232 / RS-485 input.)

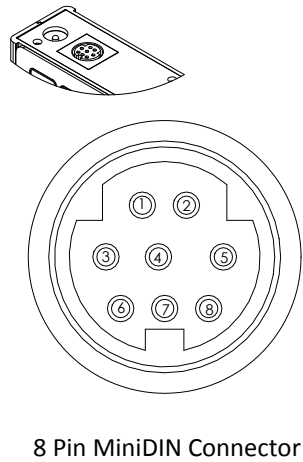
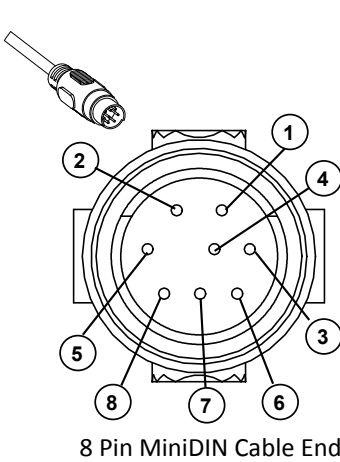
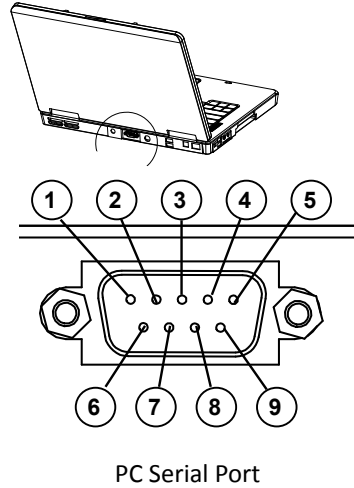
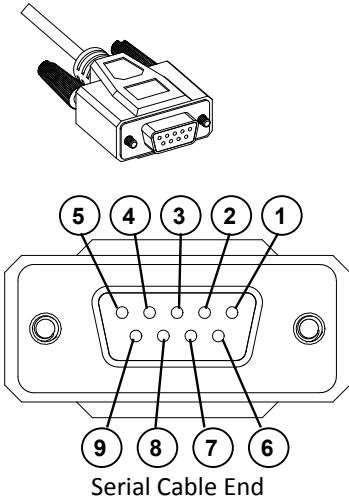

9 Pin Serial Connection		8 Pin MiniDIN Connection	
Pin	Function	Function	Pin
5	Ground	Ground	8
3	Transmit	Receive	3
2	Receive	Transmit	5

DB9 to Mini-DIN Connection for RS-232 / RS-485 Signals

OUTPUT SIGNALS

RS-232 / RS-485 Digital Output Signal

To use the RS-232 or RS-485 output signal, it is necessary to connect the RS-232 / RS-485 Output Signal (Pin 5), the RS-232 / RS-485 Input Signal (Pin 3), and Ground (Pin 8) to your computer serial port as shown on page 8. (See page 32 for details on accessing RS-232 / RS-485 output.)

Standard Voltage (0-5 Vdc) Output Signal

Meters/controllers equipped with a 0-5 Vdc (optional 0-10 Vdc) will have this output signal available on Pin 6. This output is generally available in addition to other optionally ordered outputs. This voltage is usually in the range of 0.010 Vdc for zero flow and 5.0 Vdc for full-scale flow. The output voltage is linear over the entire range. Ground for this signal is common on Pin 8.

Optional 0-10 Vdc Output Signal

If your meter/controller was ordered with a 0-10 Vdc output signal, it will be available on Pin 6. (See the Calibration Data Sheet that shipped with your meter to determine which output signals were ordered.) This voltage is usually in the range of 0.010 Vdc for zero flow and 10.0 Vdc for full-scale flow. The output voltage is linear over the entire range. Ground for this signal is common on Pin 8.

Optional Current (4-20 mA) Output Signal

If your meter/controller was ordered with a 4-20 mA current output signal, it will be available on Pin 1. (See the Calibration Data Sheet that shipped with your meter to determine which output signals were ordered.) The current signal is 4 mA at 0 flow and 20 mA at the meter's full scale flow. The output current is linear over the entire range. Ground for this signal is common on Pin 8. (Current output units require 15-30Vdc power.)

Optional 2nd Analog Output Signal

You may specify an optional 2nd analog output on Pin 2 at time of order. (See the Calibration Data Sheet that shipped with your meter to determine which output signals were ordered.) This output may be a 0-5 Vdc, 0-10 Vdc, or 4-20 mA analog signal that can represent any measured parameter. With this optional output, a meter could output the volume flow rate (0-5 Vdc on pin 6) and the line temperature (0-5 Vdc on pin 2).



If your device is equipped with the optional six pin industrial connector, please contact Your dealer.



CAUTION! DO NOT CONNECT THIS DEVICE TO "LOOP POWERED" SYSTEMS, AS THIS WILL DESTROY PORTIONS OF THE CIRCUITRY AND VOID THE WARRANTY. IF YOU MUST INTERFACE WITH EXISTING LOOP POWERED SYSTEMS, ALWAYS USE A SIGNAL ISOLATOR AND A SEPARATE POWER SUPPLY.



CAUTION! DO NOT CONNECT THIS DEVICE TO "LOOP POWERED" SYSTEMS, AS THIS WILL DESTROY PORTIONS OF THE CIRCUITRY AND VOID THE WARRANTY. IF YOU MUST INTERFACE WITH EXISTING LOOP POWERED SYSTEMS, ALWAYS USE A SIGNAL ISOLATOR AND A SEPARATE POWER SUPPLY.

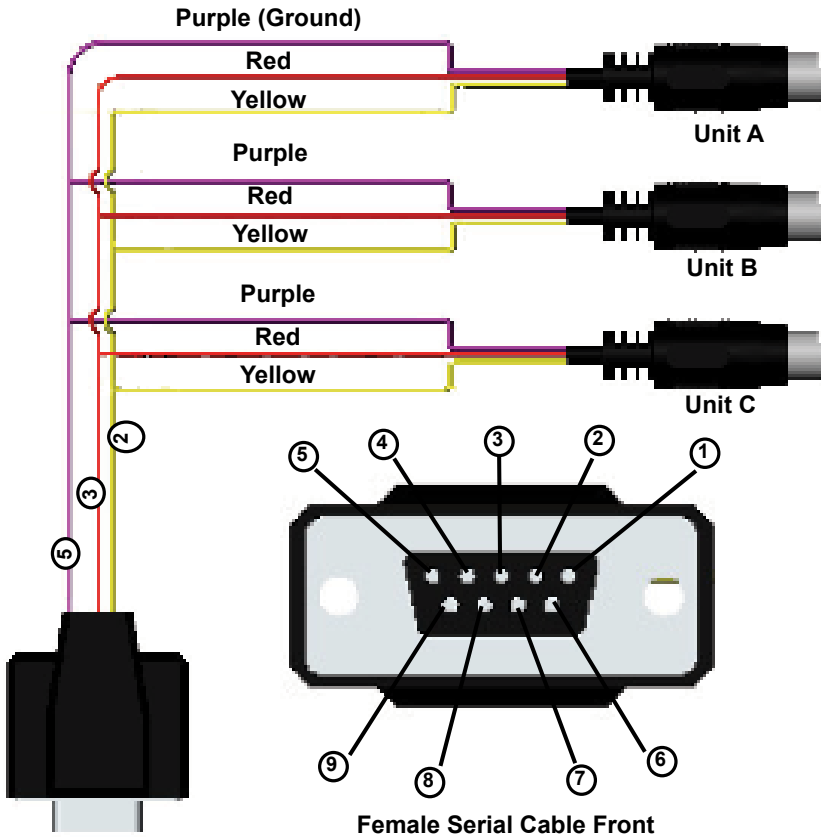

Typical Multiple Device (Addressable) Wiring Configuration



The easiest way to connect multiple devices is with a Multi-Drop Box (see page 48).

Information for TFT (Color Display) Instruments

TFT (color display) instruments have a high contrast back-lit LCD display. TFT instruments operate in accordance with standard operating instructions for our monochrome menus and displays with the following differences.

Multi-Color Display Color Codes:

GREEN: Green labels identify the parameters and/or adjustments associated with the button directly above or below the label.

WHITE: The color of each parameter is displayed in white while operating under normal conditions.

RED: The color of a parameter is displayed in red when operating conditions for that parameter exceed 128% of the device's specifications.

YELLOW: Yellow is the equivalent of the selection arrow on the monochrome display.

LCD Contrast:

LCD contrast is ranged from 0 to 11 on color displays with 11 being the greatest contrast.

Display On/Off:

Pushing the button under the display will turn the device display on or off. This feature is not available on monochrome displays.

Technical Data for TFT (Color Display) Meters, Gauges and Controllers

The following specifications are applicable to **TFT** (color display) meters, gauges and controllers only. All other operating specifications are shown in the Technical Data page for standard instruments. All standard device features and functions are available and operate in accordance with the operating manual provided with the device.

Specification	Meter or Gauge	Small Valve Controller	Large Valve Controller
Supply Voltage	7 to 30 Vdc	12 to 30 Vdc	24 to 30 Vdc
Supply Current	80 mA @ 12Vdc 70 mA @ 24Vdc	290 mA @ 12Vdc 200 mA @ 24Vdc	780 mA @ 24Vdc

DISPLAYS AND MENUS L METERS

(Displays and Menus for LC and LCR Controllers are shown beginning page 25.)

The device screen defaults to **Main** display as soon as power is applied to the meter.

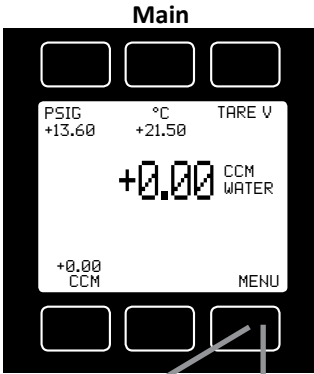

The **Main** display shows, temperature and volume flow. Line pressure will be also be displayed if the meter was order with this option.

Pressing the button adjacent to a parameter will make that parameter the primary display unit.

By hitting the **MENU** button at the bottom right of the screen you will enter the **Select Menu** display.

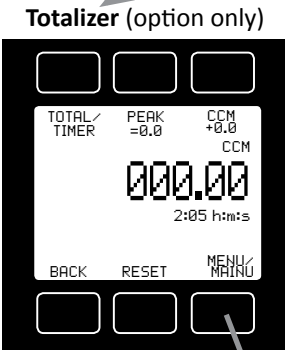

If your meter was ordered with the **Totalizer** option (page 44), pushing the **TOTAL** button once will bring up the **Totalizing Mode** display. Pushing **MENU** a second time will bring up the **Select Menu** display.

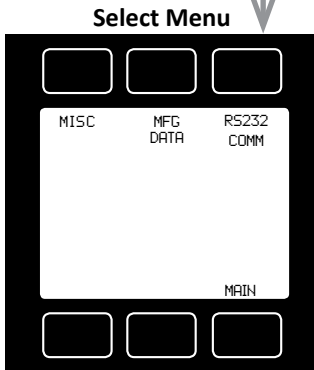

Select Menu

From **Select Menu** you can interact with your RS-232 / RS-485 settings or read manufacturer's data.

Push **MAIN** to return to the Main display.

MAIN

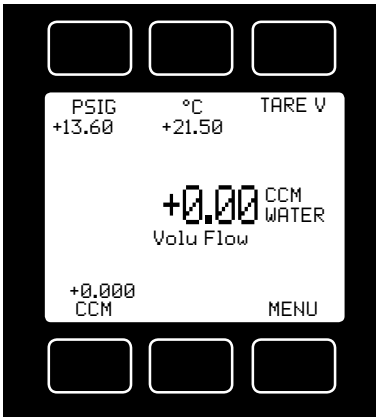

This mode defaults on power up, with flow as the primary displayed parameter.

The following parameters are displayed in the Main mode.

Line Pressure: *Only on units equipped with the optional pressure sensor*, pressing the **PSIG** button will move the line gauge pressure to the primary display.

Line Temperature: Pressing the **°C** button will move the process temperature to the primary display.

Pushing the button again allows you to select °C (Celsius), K (Kelvin), °F (Fahrenheit) or °R (Rankine) for the temperature scale.

To select a temperature scale, use the UP and DOWN buttons to position the arrow in front of the desired scale.

Press SET to record your selection and return to the MAIN display. The selected temperature scale will be displayed on the screen.

Tare: Pushing the **TARE V** button tares the flow meter and provides it with a reference point for zero flow. This is an important step in obtaining accurate measurements. It is best to zero the flow meter each time

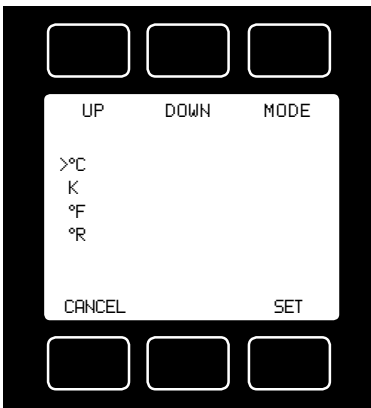

it is powered up. If the flow reading varies significantly from zero after an initial tare, give the unit a minute or so to warm up and re-zero it.

If possible, zero the unit near the expected operating pressure by positively blocking the flow downstream of the flow meter prior to pushing the TARE button.

 **Zeroing the unit while there is any flow will directly affect the accuracy by providing a false zero point.**

If in doubt about whether a zero flow condition exists, remove the unit from the line and positively block both ports before pressing the TARE button. If the unit reads a significant negative value when removed from the line and blocked, it was given a false zero. It is better to zero the unit at atmospheric pressure and a confirmed no flow condition than to give it a false zero under line pressure.

It is not uncommon for a meter to read a small value when it is removed from the process line as water can “hang” in one or both of the differential pressure sensor ports. If the unit reads a significant negative value when removed from the line and blocked, it is a good indication that it was given a false zero.

Volume: The volume flow rate is defaulted on the primary display. Press the unit of measure button (ccm in the example above) to return the volume flow rate to the primary display.

MENU: Pressing **MENU** switches the screen to the **Select Menu** display.



Flashing Error Message: An error message (**VOV** = volumetric overrange, **POV** = pressure overrange, **TOV** = temperature overrange) flashes when a measured parameter exceeds the range of the sensor. When any item flashes, neither the flashing parameter nor the flow measurement is accurate. Reducing the value of the flashing parameter to within specified limits will return the unit to normal operation and accuracy.

If the unit does not return to normal operation contact Your dealer.

SELECT MENU

From Select Menu you can interact with your RS-232 / RS-485 settings or read manufacturer’s data.

Press the button next to the desired operation to bring that function to the screen.

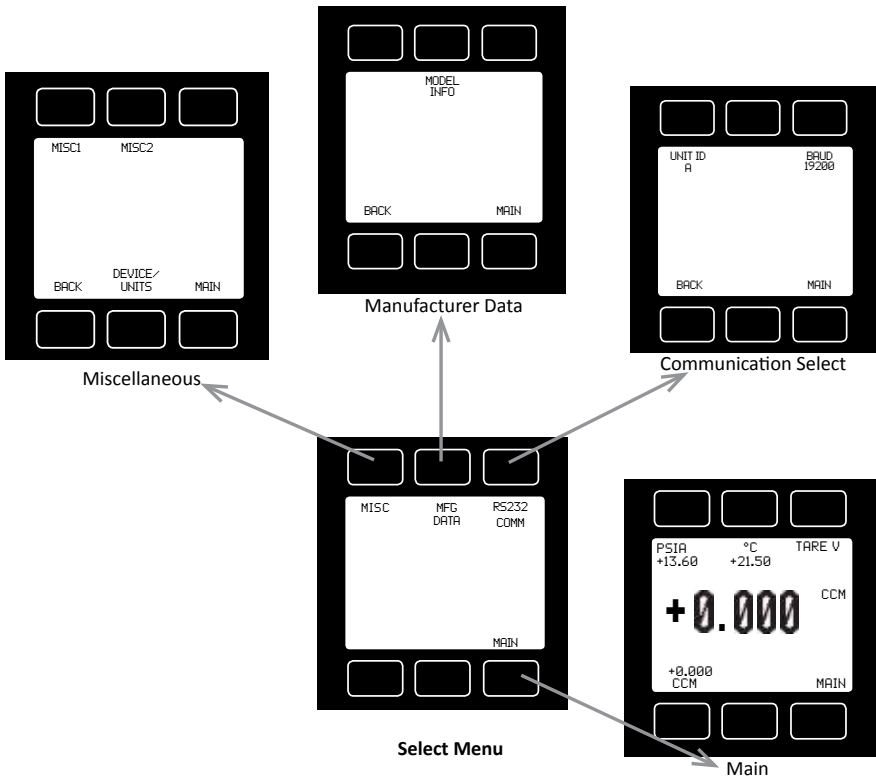

An explanation for each screen can be found on the following pages.

COMMUNICATION SELECT

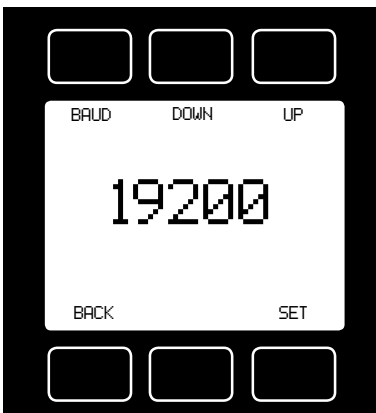
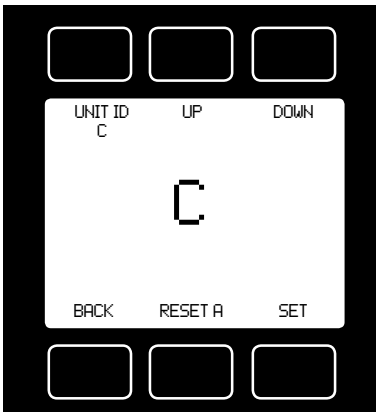
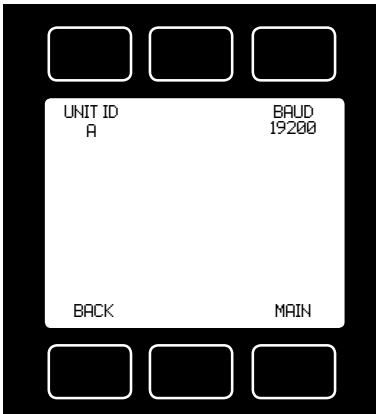

Access **Communication Select** by pressing the button above **RS232 COMM** or **RS485 COMM** on the **Select Menu** display.

Unit ID – Valid unit identifiers are the letters A-Z and @. The identifier allows you to assign a unique address to each device so that multiple units can be connected to a single RS-232 or RS-485 computer port.

Press **UNIT ID**. Use the UP and DOWN buttons to change the Unit ID. Press SET to record the ID. Press Reset to return to the previously recorded Unit ID.

Any Unit ID change will take effect when Communication Select is exited.

If the symbol @ is selected as the Unit ID, the device will enter streaming mode when Communication Select is exited. See RS-232 Communications (page 32) for information about the streaming mode.

Baud – Both this instrument and your computer must send/receive data at the same baud rate. The default baud rate for this device is 19200 baud.

Press the Select button until the arrow is in front of **Baud**. Use the UP and DOWN buttons to select the baud rate that matches your computer. The choices are 38400, 19200, 9600, or 2400 baud.

Any baud rate change will not take effect until power to the unit is cycled.

MISCELLANEOUS

Miscellaneous is accessed by pressing the **MISC** button on the Select Menu display. Next select either **MISC1** or **MISC2**.

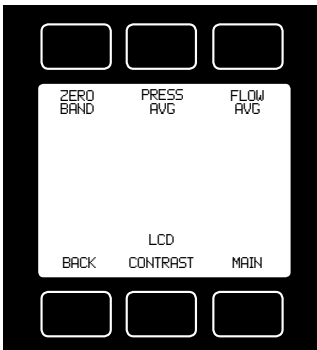

MISC1 will display as shown at left.

ZERO BAND refers to Display Zero Deadband.

Zero deadband is a value below which the display jumps to zero. This deadband is often desired to prevent electrical noise from showing up on the display as minor flows or pressures that do not exist. Display Zero Deadband does not affect the analog or digital signal outputs.

ZERO BAND can be adjusted between 0 and 6.3% of the sensor's Full Scale (FS).

Press **ZERO BAND**. Then use SELECT to choose the digit with the arrow and the UP and DOWN buttons to change the value. Press SET to record your value. Press CLEAR to return to zero.

Pressure Averaging and Flow Averaging may be useful to make it easier to read and interpret rapidly fluctuating pressures and flows. Pressure and flow averaging can be adjusted between 1 (no averaging) and 256 (maximum averaging).

These are geometric running averages where the number between 1 and 256 can be considered roughly equivalent to the response time constant in milliseconds.

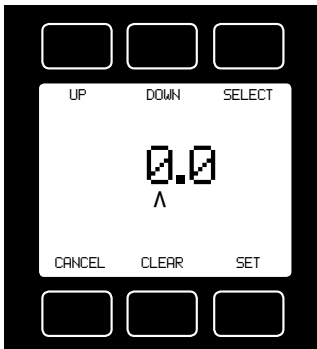

This can be effective at "smoothing" high frequency process oscillations such as those caused by diaphragm pumps.

Press **PRESS AVG**. Then use SELECT to choose the digit with the arrow and the UP and DOWN buttons to change the value. Press SET to record your value. Press CLEAR to return to zero.

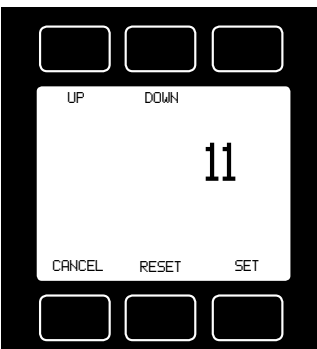

Press **FLOW AVG**. Then use SELECT to choose the digit with the arrow and the UP and DOWN buttons to change the value. Press SET to record your value. Press CLEAR to return to zero.

Setting a higher number will equal a smoother display.

LCD CONTRAST: The display contrast can be adjusted between 0 and 31, with zero being the lightest and 31 being the darkest. Use the UP and DOWN buttons to adjust the contrast. Press SET when you are satisfied. Press CANCEL to return to the MISC display.

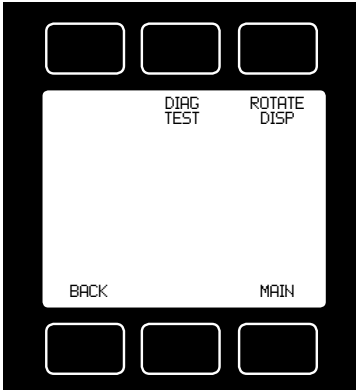

MISC2 will display as shown at left.

Press **ROTATE DISP** and SET to **Inverted 180°** if your device is inverted. The display and buttons will rotate together.

If the device has been installed upside down, avoid using the bleed screws as water may leak into the electronics housing causing permanent damage that is not covered under warranty!

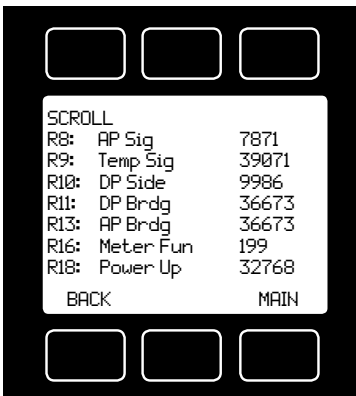

DIAG TEST: This diagnostic screen displays the current internal register values, which is useful for noting factory settings prior to making any changes. It is also helpful for troubleshooting with customer service personnel.

Select the **DIAG TEST** button from the **MISC2** screen to view a list of select register values.

Pressing the **SCROLL** button will cycle the display through the register screens. An example screen is shown at left.

DEVICE UNITS

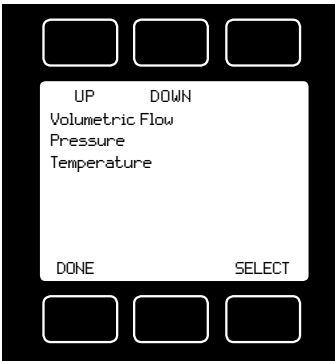

Press **DEVICE UNITS** to access menus of units of measure for each parameter (and totalizer if so equipped).

Scroll to the desired unit and press select.

Once selected, you will see the message shown below. Verify that all connected devices expect the change.

See pages 40 and 41 for a full list of available units.

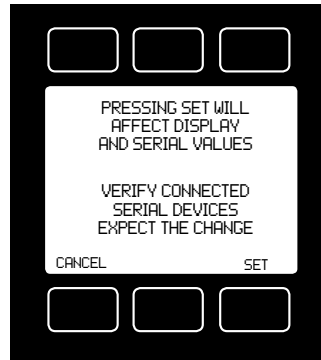
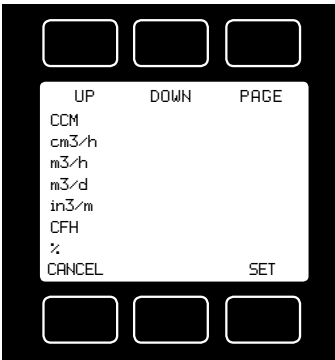

MANUFACTURER DATA

Manufacturer Data is accessed by pressing the **MFG DATA** button on the Select Menu display. The initial display will be blank. Press **MODEL INFO** to show important information about your flow device including the model number, serial number, and date of manufacture.

Press **BACK** to return to the MFG DATA display.

Push **MAIN** to return to the Main display.

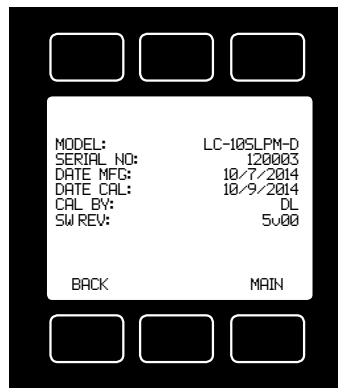
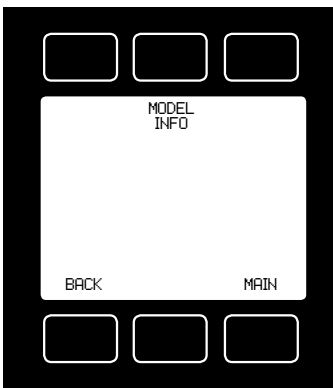

DISPLAYS AND MENUS LC AND LCR CONTROLLERS

(Displays and Menus for L Meters are shown beginning page 18.)

The device screen defaults to **Main** display as soon as power is applied to the controller.

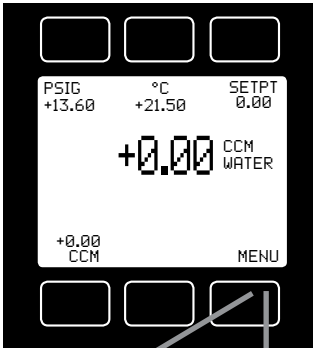

The **Main** display shows, temperature and volume flow. Line pressure will be also be displayed if the meter was order with this option.

Pressing the button adjacent to a parameter will make that parameter the primary display unit.

By hitting the **MENU** button at the bottom right of the screen you will enter the **Select Menu** display.

Totalizer (option only)

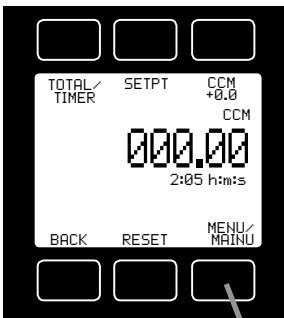

If your controller was ordered with the **Totalizer** option (page 44), pushing the **TOTAL** button once will bring up the **Totalizing Mode** display. Pushing **MENU** will bring up the **Select Menu** display.

Select Menu

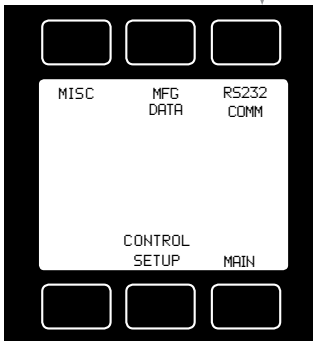

Select Menu

From **Select Menu** you can interact with your RS-232 / RS-485 settings, read manufacturer's data or access the control set-up display.

Push **MAIN** to return to the Main display.

MAIN



This mode defaults on power up, with flow as the primary displayed parameter.

The following parameters are displayed in the Main mode.

Line Pressure: *Only on units equipped with the optional pressure sensor*, pressing the **PSIG** button will move the line gauge pressure to the primary display.

Line Temperature: Pressing the **°C** button will move the process temperature to the primary display.

Set Point: The set-point (**SETPT**) is shown in the upper right of the display.

For information on changing the set-point see SETPT SOURCE, page 28.

Volume: The volume flow rate is defaulted on the primary display. Press the unit of measure button (ccm in the example above) to return the volume flow rate to the primary display.

MENU: Pressing **MENU** switches the screen to the **Select Menu** display.



Flashing Error Message: An error message (**VOV** = volumetric overrange, **POV** = pressure overrange, **TOV** = temperature overrange) flashes when a measured parameter exceeds the range of the sensor. When any item flashes, neither the flashing parameter nor the flow measurement is accurate. Reducing the value of the flashing parameter to within specified limits will return the unit to normal operation and accuracy.

If the unit does not return to normal operation contact Your dealer.

SELECT MENU

From Select Menu you can change the selected gas, interact with your RS-232 / RS-485 settings, read manufacturer's data and access the control setup screen.

Press the button next to the desired operation to bring that function to the screen.

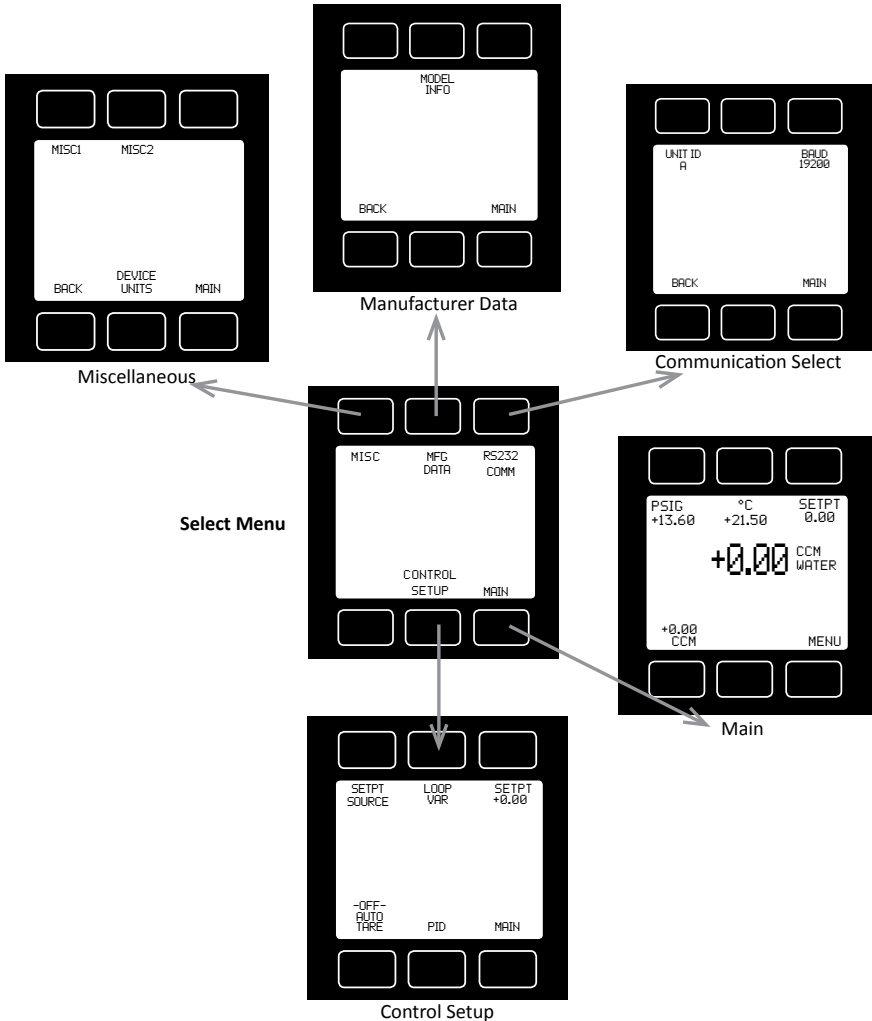

An explanation for each screen can be found on the following pages:

Control Setup: Please see page 28.

Communication Select: Please see page 21.

Miscellaneous: Please see page 22.

Manufacturer Data: Please see page 24.

CONTROL SETUP

Control Setup is accessed by pressing the button below Control Setup on the Select Menu display. From this screen you can select your set-point source, choose a loop variable and adjust the PID terms.

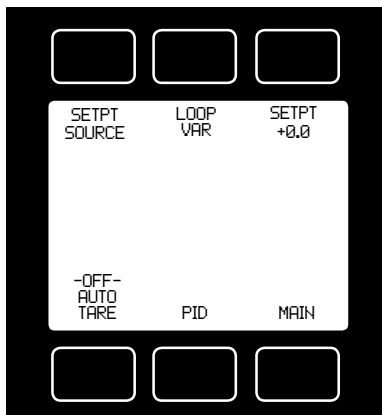

Press BACK to return to the Select Menu display.

Press MAIN to return to the MAIN display

SETPT SOURCE – Pressing the button above SETPT SOURCE will allow you to select how the set point will be conveyed to your controller.

Use the line-up and line-down buttons to move the arrow in front of the desired option. Then press SET.

Press CANCEL to return to the previous display.

The controller will ignore any set-point except that of the selected set-point source and it will remember which input is selected even if the power is disconnected.

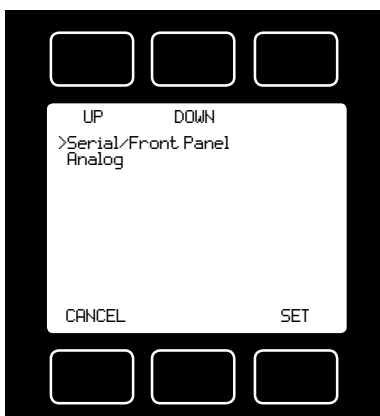

Serial refers to a remote digital RS-232 / RS-485 set-point applied via a serial connection to a computer or PLC as described in the installation and RS-232 / RS-485 sections of this manual.

Front Panel refers to a set-point applied directly at the controller.

 **Front Panel input must be selected prior to changing the set-point at the device.**

Analog refers to a remote analog set-point applied to Pin 4 of the Mini-DIN connector as described in the installation

section of this manual. **The standard analog input is 0-5 Vdc.**

 **To determine what type of analog set-point your controller has, refer to the Calibration Data Sheet that was included with your controller.**

If nothing is connected to Pin 4, and the controller is set for analog control, the device will generate random set-point values.

NOTE: If your controller has the IPC (Integrated Potentiometer Control) option, the IPC dial will operate with the ANALOG set-point source selected.

SETPT refers to the **set-point**. This parameter may be changed using the display only if **FRONT PANEL** is selected as the Input. Press **SETPT**. Then use SELECT to choose the decimal with the arrow and the UP and DOWN buttons to change the value. Press SET to record your value. Press CLEAR to return to zero.



CAUTION! NEVER LEAVE A CONTROLLER WITH A NON-ZERO SET-POINT IF NO PRESSURE IS AVAILABLE TO MAKE FLOW. THE CONTROLLER WILL APPLY FULL POWER TO THE VALVE IN AN ATTEMPT TO REACH THE SET-POINT. WHEN THERE IS NO FLOW, THIS CAN MAKE THE VALVE VERY HOT!

CONTROL SETUP (continued)

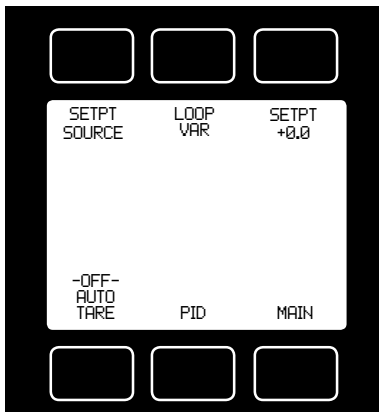

LOOP VAR—Water flow controllers are defaulted to volume flow.

Volume means that the controller is “closing the loop” on the volume flow rate. This means that when you give the controller a set-point, the controller compares that set-point to the measured volume flow rate and adjusts the valve to try to make the flow and the set-point match. For the volume flow rate, the input signal (e.g. 0-5 Vdc) corresponds to the full-scale flow rate for the device.

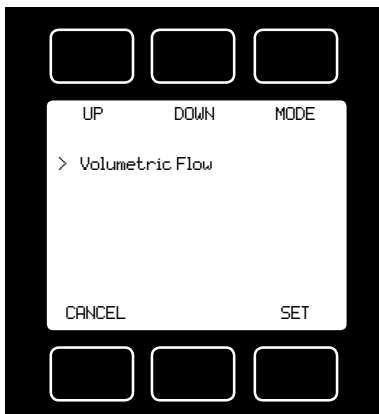

ON AUTO / OFF AUTO—refers to the standard auto-tare or “auto-zero” feature.

The auto-tare feature automatically tares (takes the detected signal as zero) the unit when it receives a zero set-point for more than two seconds.

A zero set-point results in the closing of the valve and a known “no flow” condition. This feature makes the device more accurate by periodically removing any cumulative errors associated with drift.



It is recommended that the controller be left in the default auto-tare ON mode unless your specific application requires that it be turned off.

PID TUNING

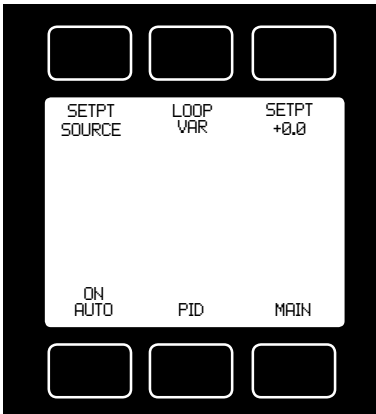

PID Values determine the performance and operation of your proportional control valve. These terms dictate control speed, control stability, overshoot and oscillation. All units leave the factory with a generic tuning designed to handle most applications. If you encounter issues with valve stability, oscillation or speed, fine tuning these parameters may resolve the problem.

L-Series controllers allow you to adjust the Proportional, Integral and Differential terms of the PID control loop.

To change the PID loop parameters, push the button below **PID**.

Press **LOOP TYPE**. Then use the LN-UP and LN-DN buttons to select the appropriate PID control algorithm. Press SET.

See the following page for descriptions of the PID Loop Types (PID Control Algorithms).

P refers to the Proportional term of the PID loop.

I refers to the Integral term of the PID loop.

D refers to the Differential term of the PID loop.

Press P, I or D. Then use SELECT to choose the decimal with the arrow and the UP and DOWN buttons to change the value. Press SET to record your value. Press CLEAR to return to zero.



Before changing the P, I or D parameter, please record the initial value so that it can be returned to the factory setting if necessary.

Valve tuning can be complex. If you would like assistance, please contact your dealer for technical support.

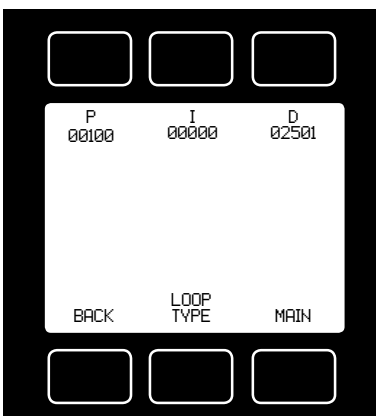
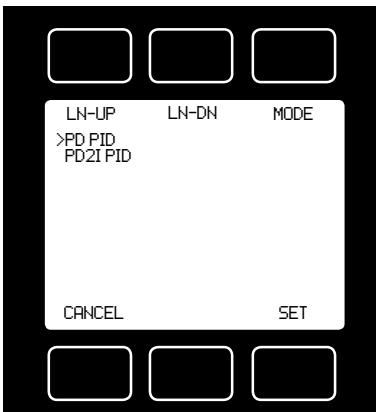

The PD algorithm is the PID algorithm used on most LC-Series controllers.

It is divided into two segments:

The first compares the process value to the set-point to generate a proportional error. The proportional error is multiplied by the 'P' gain, with the result added to the output drive register.

The second operates on the present process value minus the process value during the immediately previous evaluation cycle. This 'velocity' term is multiplied by the 'D' gain, with the result subtracted from the output drive register.

The above additions to and subtractions from the output drive register are carried over from process cycle to process cycle, thus performing the integration function automatically.

Increasing the 'P' gain will **promote** the tendency of the system to overshoot, ring, or oscillate.

Increasing the 'D' gain will **reduce** the tendency of the system to overshoot.

The PD21 algorithm is a PID algorithm used primarily for high performance pressure and flow control applications.

It exhibits two basic differences from the PD algorithm that most controllers utilize.

1. Instead of applying a damping function based upon the rate of change of the process value, it applies a damping function based upon the square of the rate of change of the process value.
2. The damping function is applied directly to the proportional error term before that term is used in the proportional and integral functions of the algorithm. This provides a certain amount of 'look ahead' capability in the control loop.

Because of these differences, you will note the following:

1. Increasing 'P' gain can be used to damp out overshoot and slow oscillations in pressure controllers. You will know that 'P' gain is too high, when the controller breaks into fast oscillations on step changes in set-point. On flow controllers, too high a 'P' gain results in slower response times. Too low a 'P' gain results in overshoot and/or slow oscillation. A good starting value for 'P' gain is 200.
2. If the unit was originally shipped with the PD21 algorithm selected, the 'D' gain value should be left at or near the factory setting because it relates primarily to the system phase lags. If you are changing from the default algorithm to the PD21 algorithm, you should start with a 'D' gain value of 20.
3. The 'I' gain is used to control the rate at which the process converges to the set-point, after the initial step change. Too low a value for 'I' gain shows up as a process value that jumps to near the set-point and then takes awhile to converge the rest of the way. Too high a value for 'I' gain results in oscillation. A good starting value for the 'I' gain is 200.

RS-232 / RS-485 Output and Input

Configuring HyperTerminal®:

1. Open your HyperTerminal® RS-232 / RS-485 terminal program (installed under the “Accessories” menu on all Microsoft Windows® operating systems).
2. Select “Properties” from the file menu.
3. Click on the “Configure” button under the “Connect To” tab. Be sure the program is set for: 19,200 baud (or matches the baud rate selected in the RS-232 / RS-485 communications menu on the meter) and an 8-N-1-None (8 Data Bits, No Parity, 1 Stop Bit, and no Flow Control) protocol.
4. Under the “Settings” tab, make sure the Terminal Emulation is set to ANSI or Auto Detect.
5. Click on the “ASCII Setup” button and be sure the “Send Line Ends with Line Feeds” box is not checked and the “Echo Typed Characters Locally” box and the “Append Line Feeds to Incoming Lines” boxes are checked. Those settings not mentioned here are normally okay in the default position.
6. Save the settings, close HyperTerminal® and reopen it.

Streaming Mode (RS-485 units do not have a streaming mode)

In the **default** Polling Mode, the screen should be blank except the blinking cursor. In order to get the data streaming to the screen, hit the “Enter” key several times to clear any extraneous information. Type “* @=@” followed by “Enter” (or using the RS-232 / RS-485 communication select menu, select @ as identifier and exit the screen). If data still does not appear, check all the connections and COM port assignments.

Streaming Mode – Advanced

The streaming data rate is controlled by register 91. The recommended default rate of data provision is once every 50 milliseconds and this is suitable for most purposes.

If a slower or faster streaming data rate is desired, register 91 can be changed to a value from 1 millisecond to 65535 milliseconds, or slightly over once every minute.

Below approximately 40 milliseconds, data provision will be dependent upon how many parameters are selected. Fewer data parameters can be streamed more quickly than more. It is left to the user to balance streaming speed with number of parameters streamed.

To read register 91, type “*r91” followed by “Enter”.

To modify register 91, type “*w91=X”, where X is a positive integer from 1 to 65535, followed by “Enter”.

To return to the recommended factory default streaming speed, type “*w91= 50”.

Tareing via RS-232 / RS-485 (L-Series only):

Tareing (or zeroing) the flow meter provides it with a reference point for zero flow. This is a very simple but important step in obtaining accurate measurements. It is good practice to “zero” the flow meter each time it is powered up.

If the flow reading varies significantly from zero after an initial tare, give the unit a minute or so to warm up and re-zero it. If possible, it is helpful to zero the unit near the expected operating pressure by positively blocking the flow downstream of the flow meter prior to entering the Tare command. Zeroing the unit while there is any flow will directly affect the accuracy by providing a false zero point.

If in doubt about whether the flow is positively blocked, remove it from the line and positively block both ports before entering the Tare command. If the unit reads a significant negative value when removed from the line and blocked, it is a good indication that it was given a false zero. It is better to zero the unit at atmospheric pressure and a confirmed no flow conditions than to give it a false zero under line pressure. To send a Tare command via RS-232 / RS-485, enter the following strings:

In Polling Mode: Address\$\$V<Enter> (e.g. B\$\$V<Enter>)

Sending a Set-point via RS-232 / RS-485: To send a set-point via RS-232 / RS-485, “Serial” must be selected under the “Input” list in the control set up mode.

Method 1: Set-point may be set in floating point in serial communication using serial command (UnitID)SX.YZ

Example: AS4.54 results in Unit ID A changing set-point to 4.54.

Method 2: Type in a number between 0 and 65535 (2% over range), where 64000 denotes full-scale flow rate, and hit “Enter”.

The set-point column and pressure rates should change accordingly. If they do not, try hitting “Enter” a couple of times and repeating your command. The formula for performing a linear interpolation is as follows:

$$\text{Value} = (\text{Desired Set-point} \times 64000) / \text{Full Scale Flow Range}$$

For example, if your device is a 500 ccm full-scale unit and you wish to apply a set-point of 125 ccm you would enter the following value:

$$16000 = (125 \text{ ccm} \times 64000) / \text{Full Scale Flow Range}$$

If the controller is in polling mode as described in Changing from Streaming Mode to Polling Mode, the set-point must be preceded by the address of the controller. For example, if your controller has been given an address of D, the set-point above would be sent by typing:

D16000 followed by “Enter”

To adjust the Proportional and Differential (P&D) terms via RS-232 / RS-485 (LC and LCR-Series only):

Type ***@=A** followed by “Enter” to stop the streaming mode of information.

To adjust the “P” or proportional term of the PID controller, type ***R21** followed by “Enter”.

The computer will respond by reading the current value for register 21 between 0-65535. It is good practice to write this value down so you can return to the factory settings if necessary. Enter the value you wish to try by writing the new value to register 21. For example, if you wished to try a “P” term of 220, you would type ***W21=220** followed by “Enter” where the bold number denotes the new value.

The computer will respond to the new value by confirming that 21=220. To see the effect of the change you may now poll the unit by typing A followed by “Enter”. This does an instantaneous poll and returns the values once. You may type A “Enter” as many times as you like. Alternately, you could resume streaming mode by typing ***@=@** followed by “Enter”. Repeat step 3 to remove the unit from the streaming mode.

To adjust the “D” or proportional term of the PID controller, type ***R22** followed by “Enter”.

The computer will respond by reading the current value for register 22 between 0-65535. It is good practice to write this value down so you can return to the factory settings if necessary. Enter the value you wish to try by writing the new value to register 22. For example, if you wished to try a “D” term of 25, you would type ***W22=25** followed by “Enter” where the bold number denotes the new value.

The computer will respond to the new value by confirming that 22=25. To see the effect of the change you may now poll the unit by typing A followed by “Enter”. This does an instantaneous poll and returns the values once. You may type A “Enter” as many times as you like. Alternately you could resume streaming mode by typing ***@=@** followed by “Enter”. Repeat.

You may test your settings for a step change by changing the set-point. To do this type A32000 (A is the default single unit address, if you have multiple addressed units on your RS-232 / RS-485 line the letter preceding the value would change accordingly.) followed by “Enter” to give the unit a ½ full scale set-point. Monitor the unit’s response to the step change to ensure it is satisfactory for your needs. Recall that the “P” term controls how quickly the unit goes from one set-point to the next, and the “D” term controls how quickly the signal begins to “decelerate” as it approaches the new set-point (controls the overshoot).

Changing From Streaming to Polling Mode:

When the meter is in the Streaming Mode (*RS-485 units do not have a streaming mode*), the screen is updated approximately 10-60 times per second (depending on the amount of data on each line) so that the user sees the data essentially in real time. It is sometimes desirable, and necessary when using more than one unit on a single RS-232 line, to be able to poll the unit.

In Polling Mode the unit measures the flow normally, but only sends a line of data when it is "polled". Each unit can be given its own unique identifier or address. Unless otherwise specified each unit is shipped with a default address of capital A. Other valid addresses are B thru Z.

Once you have established communication with the unit and have a stream of information filling your screen:

1. Type `*@=A` followed by "Enter" (or using the RS-232 / RS-485 communication select menu, select A as identifier and exit the screen) to stop the streaming mode of information. Note that the flow of information will not stop while you are typing and you will not be able to read what you have typed. Also, the unit does not accept a backspace or delete in the line so it must be typed correctly. If in doubt, simply hit enter and start again. If the unit does not get exactly what it is expecting, it will ignore it. If the line has been typed correctly, the data will stop.
2. You may now poll the unit by typing A followed by "Enter". This does an instantaneous poll of unit A and returns the values once. You may type A "Enter" as many times as you like. Alternately you could resume streaming mode by typing `*@=@` followed by "Enter". Repeat step 1 to remove the unit from the streaming mode.
3. To assign the unit a new address, type `*@=New Address`, e.g. `*@=B`. Care should be taken not to assign an address to a unit if more than one unit is on the RS-232 / RS-485 line as all of the addresses will be reassigned. Instead, each should be individually attached to the RS-232 / RS-485 line, given an address, and taken off. After each unit has been given a unique address, they can all be put back on the same line and polled individually.

Collecting Data:

The RS-232 / RS-485 output updates to the screen many times per second. Very short-term events can be captured simply by disconnecting (there are two telephone symbol icons at the top of the HyperTerminal® screen for disconnecting and connecting) immediately after the event in question. The scroll bar can be driven up to the event and all of the data associated with the event can be selected, copied, and pasted into Microsoft® Excel® or other spreadsheet program as described below.

For longer term data, it is useful to capture the data in a text file. With the desired data streaming to the screen, select "Capture Text" from the Transfer Menu. Type in the path and file name you wish to use. Push the start button. When the data collection period is complete, simply select "Capture Text" from the Transfer Menu and select "Stop" from the sub-menu that appears.

Data that is selected and copied, either directly from HyperTerminal® or from a text file can be pasted directly into Excel®. When the data is pasted it will all be in the selected column. Select "Text to Columns..." under the Data menu in Excel® and a Text to Columns Wizard (dialog box) will appear. Make sure that "Fixed Width" is selected under Original Data Type in the first dialog box and click "Next". In the second dialog box, set the column widths as desired, but the default is usually acceptable. Click on "Next" again. In the third dialog box, make sure the column data format is set to "General", and click "Finish". This separates the data into columns for manipulation and removes symbols such as the plus signs from the numbers. Once the data is in this format, it can be graphed or manipulated as desired.



For extended term data capture see: "Sending a Simple Script to HyperTerminal®" on page 38.

Data Format:

The data stream on the screen represents the flow parameters of the main mode in the units shown on the display. For L-Series Flow Meters, there are three columns of data. The first column is line pressure (normally in psig and only in units equipped with the optional pressure sensor), the second column line temperature (normally in °C), and the third column is the volume flow rate in the units specified at time of order and shown on the display.

+014.70	+025.00	+4.123
+014.70	+025.00	+4.123
+014.70	+025.00	+4.123
+014.70	+025.00	+4.123
Pressure	Temp	Vol. Flow

L-Series Water Flow Meter Data Format

For LC-Series Flow Controllers, there are four columns of data representing pressure, temperature, volume flow and set-point. The first column is line pressure (normally in psig and only in units equipped with the optional pressure sensor), the second column is temperature (normally in °C), the third column is volume flow rate (in the units specified at time of order and shown on the display), and the fourth column is the set-point (also in the units specified at time of order and shown on the display). For instance, if the meter was ordered in units of ccm, the display on the meter would read 2.004 ccm and the last two columns of the output below would represent volume flow and set-point in ccm respectively.

+014.70	+025.00	+02.004	02.004
+014.70	+025.00	+02.005	02.004
+014.70	+025.00	+02.006	02.004
+014.70	+025.00	+02.005	02.004
Pressure	Temp	Vol. Flow	Set-Point

LC-Series Water Flow Controller Data Format

Note: On units with the totalizer function a fourth column (meters) or fifth column (controllers) will show the totalizer value

Sending a Simple Script File to HyperTerminal®

It is sometimes desirable to capture data for an extended period of time. Standard streaming mode information is useful for short term events, however, when capturing data for an extended period of time, the amount of data and thus the file size can become too large very quickly. Without any special programming skills, you can use HyperTerminal® and a text editing program such as Microsoft® Word® to capture text at defined intervals.

1. Open your text editing program, MS Word for example.
2. Set the cap lock on so that you are typing in capital letters.
3. Beginning at the top of the page, type A<Enter> repeatedly. If you're using MS Word, you can tell how many lines you have by the line count at the bottom of the screen. The number of lines will correspond to the total number of times the flow device will be polled, and thus the total number of lines of data it will produce.

For example: A
 A
 A
 A
 A
 A
 A

will get a total of six lines of data from the flow meter, but you can enter as many as you like.

The time between each line will be set in HyperTerminal.

4. When you have as many lines as you wish, go to the File menu and select save. In the save dialog box, enter a path and file name as desired and in the "Save as Type" box, select the plain text (.txt) option. It is important that it be saved as a generic text file for HyperTerminal to work with it.
5. Click Save.
6. A file conversion box will appear. In the "End Lines With" drop down box, select CR Only. Everything else can be left as default.
7. Click O.K.
8. You have now created a "script" file to send to HyperTerminal. Close the file and exit the text editing program.
9. Open HyperTerminal and establish communication with your flow device as outlined in the manual.
10. Set the flow device to Polling Mode as described in the manual. Each time you type A<Enter>, the meter should return one line of data to the screen.
11. Go to the File menu in HyperTerminal and select "Properties".
12. Select the "Settings" tab.

13. Click on the “ASCII Setup” button.

14. The “Line Delay” box is defaulted to 0 milliseconds. This is where you will tell the program how often to read a line from the script file you’ve created. 1000 milliseconds is one second, so if you want a line of data every 30 seconds, you would enter 30000 into the box. If you want a line every 5 minutes, you would enter 300000 into the box.

15. When you have entered the value you want, click on OK and OK in the Properties dialog box.

16. Go the Transfer menu and select “Send **Text** File...” (NOT Send File...).

17. Browse and select the text “script” file you created.

18. Click Open.

19. The program will begin “executing” your script file, reading one line at a time with the line delay you specified and the flow device will respond by sending one line of data for each poll it receives, when it receives it.

You can also capture the data to another file as described in the manual under “Collecting Data”. You will be simultaneously sending it a script file and capturing the output to a separate file for analysis.

FLOW MEASUREMENT OPERATING PRINCIPLE

All L or LC-Series Water Flow Meters/Controllers accurately determine the flow rate by creating a pressure drop across a unique internal restriction, known as a Laminar Flow Element (LFE), and measuring differential pressure across it. The restriction is designed so that the water molecules are forced to move in parallel paths along the entire length of the passage; hence laminar (streamline) flow is established for the entire range of operation of the device. Unlike other flow measuring devices, in laminar flow meters the relationship between pressure drop and flow is linear.

In order to have an accurate reading of the flow rate, the absolute viscosity of the fluid must be established. The rate at which liquids change viscosity with changes in temperature is not linear. The relationship between temperature and viscosity for water is well established and L and LC-Series units utilize a high accuracy temperature sensor and this relationship to provide an accurate viscosity reference. **For this reason, these meters and controllers are generally recommended only for use with pure water.** Any additives to water (such as antifreeze or disinfectants) that might affect the viscosity should be avoided.

SUPPORTED UNITS: This device supports many different units. You may select the desired units (see page 28). Note that only units appropriate to this device are available for selection.

Pressure Units

Absolute	Gauge	Differential	Notes
PaA	PaG	PaD	pascal
hPaA	hPaG	hPaD	hectopascal
kPaA	kPaG	kPaD	kilopascal
MPaA	MPaG	MPaD	megapascal
mbarA	mbarG	mbarD	millibar
barA	barG	barD	bar
g/cm2A	g/cm2G	g/cm2D	gram force per square centimeter
kg/cmA	kg/cmG	kg/cmD	kilogram force per square centimeter
PSIA	PSIG	PSID	pound force per square inch
PSFA	PSFG	PSFD	pound force per square foot
mTorrA	mTorrG	mTorrD	millitorr
torrA	torrG	torrD	torr
mmHgA	mmHgG	mmHgD	millimeter of mercury at 0 C
inHgA	inHgG	inHgD	inch of mercury at 0 C
mmH2OA	mmH2OG	mmH2OD	millimeter of water at 4 C (NIST conventional)
mmH2OA	mmH2OG	mmH2OD	millimeter of water at 60 C
cmH2OA	cmH2OG	cmH2OD	centimeter of water at 4 C (NIST conventional)
cmH2OA	cmH2OG	cmH2OD	centimeter of water at 60 C
inH2OA	inH2OG	inH2OD	inch of water at 4 C (NIST conventional)
inH2OA	inH2OG	inH2OD	inch of water at 60 C
atm			atmosphere
m asl			meter above sea level (only in /ALT builds)
ft asl			foot above sea level (only in /ALT builds)
V			volt; no conversions are performed to or from other units
count	count	count	setpoint count, 0 – 64000
%	%	%	percent of full scale

Flow Units

Volumetric	Standard	Normal	Notes
uL/m	SuL/m	NuL/m	microliter per minute
mL/s	SmL/s	NmL/s	milliliter per second
mL/m	SmL/m	NmL/m	milliliter per minute
mL/h	SmL/h	NmL/h	milliliter per hour
L/s	SL/s	NL/s	liter per second
LPM	SLPM	NLPM	liter per minute
L/h	SL/h	NL/h	liter per hour
US GPM			US gallon per minute
US GPH			US gallon per hour
CCS	SCCS	NCCS	cubic centimeter per second
CCM	SCCM	NCCM	cubic centimeter per minute
cm3/h	Scm3/h	Ncm3/h	cubic centimeter per hour
m3/m	Sm3/m	Nm3/m	cubic meter per minute
m3/h	Sm3/h	Nm3/h	cubic meter per hour
m3/d	Sm3/d	Nm3/d	cubic meter per day
in3/m	Sin3/m		cubic inch per minute
CFM	SCFM		cubic foot per minute
CFH	SCFH		cubic foot per hour
	kSCFM		1000 cubic feet per minute
count	count	count	setpoint count, 0 – 64000
%	%	%	percent of full scale

Totalizer Units

Volumetric	Standard	Normal	Notes
uL	SuL	NuL	microliter
mL	SmL	NmL	milliliter
L	SL	NL	liter
US GAL			US gallon
cm ³	Scm ³	Ncm ³	cubic centimeter
m ³	Sm ³	Nm ³	cubic meter
in ³	Sin ³		cubic inch
ft ³	Sft ³		cubic foot
	kSft ³		1000 cubic feet
uP	micropoise, a measure of viscosity; no conversions are performed to or from other units		

Temperature Units

Label	Notes
°C	degree Celsius
°F	degree Fahrenheit
K	Kelvin
°R	degree Rankine

Time Units

Label	Notes
h:m:s	Displayed value is hours:minutes:seconds
ms	millisecond
s	second
m	minute
hour	hour
day	day

Valve Drive Units

Label	Notes
count	+/- 65536 at full drive
%	Percent of full scale drive

TROUBLESHOOTING

Display does not come on or is weak.

Check power and ground connections and supply voltage. Please reference the technical specifications (page 52-57) to assure you have the proper power for your model.

Flow reading is approximately fixed either near zero or near full scale regardless of actual line flow.

Differential pressure sensor may be damaged. A common cause of this problem is instantaneous application of high pressure as from a snap acting solenoid valve upstream of the meter. If you suspect that your pressure sensor is damaged please discontinue use of the device and contact Your dealer.

Displayed volumetric flow, pressure or temperature is flashing and message VOV, POV or TOV is displayed:

Our flow meters and controllers display an error message (VOV = volumetric overrange, POV = pressure overrange, TOV = temperature overrange) when a measured parameter exceeds the range of the sensors in the device. When any item flashes on the display, neither the flashing parameter nor the flow measurement is accurate. Reducing the value of the flashing parameter to within specified limits will return the unit to normal operation and accuracy. If the unit does not return to normal contact Your dealer.

Meter reads negative flow when there is a confirmed no flow condition.

This is an indication of an improper tare. If the meter is tared while there is flow, that flow is accepted as zero flow. When an actual zero flow condition exists, the meter will read a negative flow. Simply re-tare at the confirmed zero flow condition. Also note that while the meter is intended for positive flow, it will read negative flow with reasonable accuracy (it is not calibrated for bi-directional flow) and no damage will result. See TARE page 19 .

After installation, there is no flow.

LC-Series controllers incorporate normally closed valves and require a set-point to operate. Check that your set-point signal is present and supplied to the correct pin and that the correct set-point source is selected under the SETPT SOURCE list in the control set up display (page 28). Also check that the unit is properly grounded.

My controller does not respond to the set-point.

Check that your set-point signal is present and supplied to the correct pin and that the correct set-point source is selected under the SETPT SOURCE list in the control set up display (page 28). Also check that the unit is properly grounded.

The flow lags below the set-point.

Be sure there is enough pressure available to make the desired flow rate. If either the set-point signal line and/or the output signal line is relatively long, it may be necessary to provide heavier wires (especially ground wiring) to negate voltage drops due to line wire length. An inappropriate PID tuning can also cause this symptom if the D term is too large relative to the P term (page 30).

Meter does not appear to be accurate when compared against another valid measurement of the physical flow (such as weight over time).

Water flow meters can normally be compared against one another provided there are no leaks between the two meters. One common cause of inaccuracy, inconsistency, or unusual readings is air bubbles trapped in one or both of the legs of the differential pressure sensor. Bleed the ports as described in this manual to remove this possibility (See page 11). Another possibility is that the water has some contaminant or additive, such as antifreeze, that affects the viscosity of the water. A third possibility is an improper tare error (see page 19).

Controller is slow to react to a set-point change or imparts an oscillation to the flow.

An inappropriate PID tuning can cause these symptoms. Use at conditions considerably different than those at which the device was originally set up can necessitate a re-tuning of the PID loop (page 30).

Flow flutters or is jumpy.

The meters are very fast and will pick up any actual flow fluctuations such as from a diaphragm pump, etc. Also, inspect the inside of the upstream connection for debris such a Teflon tape shreds. Note: L & LC-Series devices feature a programmable geometric running average (GRA) that can aid in allowing a rapidly fluctuating flow to be read. Please see “Pressure Averaging” and “Flow Averaging” on page 22.

The output signal is lower than the reading at the display.

This can occur if the output signal is measured some distance from the meter as voltage drops in the wires increase with distance. Using heavier gauge wires, especially in the ground wire, can reduce this effect.

My controller oscillates wildly and/or exhibits very different reactions to the set-point than I expect.

Conditions considerably different than those at which the device was originally set up can necessitate a re-tuning of the PID loop. Avoid long runs of small diameter tubing in the system, increase line size.

RS-232 / RS-485 Serial Communications is not responding.

Check that your meter is powered and connected properly. Be sure that the port on the computer to which the meter is connected is active. Confirm that the port settings are correct per the RS-232 / RS-485 instructions in this manual (Check the RS-232 / RS-485 communications select screen for current meter readings). Close HyperTerminal® and reopen it. Reboot your PC. See pages 14, 15 and 32 for more information on RS-232 / RS-485 signals and communications.

Slower response than specified.

L-Series Meters and LC-Series Controllers feature a programmable Geometric Running Average (GRA). Depending on the full scale range of the meter, it may have the GRA set to enhance the stability/readability of the display, which would result in slower perceived response time. Please see “Pressure Averaging” and “Flow Averaging” on page 22.

Jumps to zero at low flow.

L-Series Meters and LC-Series Controllers feature a programmable zero deadband. The factory setting is usually 0.5% of full scale. This can be adjusted between NONE and 6.3% of full scale. See page 22.

MAINTENANCE AND RECALIBRATION

General: L and LC-Series Water Flow Meters and Controllers require minimal maintenance. The primary cause of damage and/or long-term inaccuracy in these devices is contamination and/or corrosion damage. Water should be filtered for particulates or biological materials that may grow in the device. When removing these units from the line for any extended period of time, make an effort to remove all of the water from the device, as deposits of calcium or other soluble minerals can affect the accuracy of the device.

Recalibration: The recommended period for recalibration is once every year. A label located on the back of the device lists the most recent calibration date. The device should be returned to the factory for recalibration within one year from the listed date. Before calling to schedule a recalibration, please note the serial number on the back of the meter. The Serial Number, Model Number, and Date of Manufacture are also available on the Model Info screen (page 24).

Cleaning: L and LC-Series Flow Meters/Controllers require no periodic cleaning. If necessary, the outside of the meter can be cleaned with a soft dry cloth. Avoid excess moisture or solvents.

For repair, recalibration or recycling of this product, contact your dealer.

Flow Conversion Table:

	CCM	CCH	LPM	LPH	CFM	CFH
CFH	0.0021	0.00003	2.1189	0.035	60.0	1.0
CFM	0.000035	0.0000005	0.035	0.00059	1.0	0.0166
LPH	0.06	0.001	60.0	1.0	1699.0	28.316
LPM	0.001	0.000017	1.0	0.0166	28.316	0.4719
CCH	60.0	1.0	60000.0	1000.0	1699011.0	28317.0
CCM	1.0	0.0167	1000.0	16.667	28317.0	471.947

Option: Totalizing Mode

Meters and controllers can be purchased with the Totalizing Mode option. For controllers this option adds an additional mode screen that displays the total flow (normally in the units of the main flow screen) that has passed through the device since the last time the totalizer was cleared. The Totalizing Mode screen is accessed by pushing the TOTAL button on the MAIN display.

TOTAL/TIMER: Pushing the TOTAL/TIMER button will cycle the large numbers on the display between total mass and time elapsed.



Rollover – The customer can also specify at the time of order what the totalizer is to do when the maximum count is reached. The following options may be specified:

No Rollover – When the counter reaches the maximum count it stops counting until the counter is cleared.

Rollover – When the counter reaches the maximum count it automatically rolls over to zero and continues counting until the counter is cleared.

Rollover with Notification – When the counter reaches the maximum count it automatically

rolls over to zero, displays an overflow error, and continues counting until the counter is cleared.

TOTAL MASS: The counter can have as many as seven digits. At the time of order, the customer must specify the range. This directly affects the maximum count. For instance, if a range of 1/100ths of a liter is specified on a meter which is totalizing in liters, the maximum count would be 99999.99 liters. If the same unit were specified with a 1 liter range, the maximum count would be 9999999 liters.

ELAPSED TIME: The small numbers below the mass total show the elapsed time since the last reset in hours, minutes and seconds. The maximum measurable elapsed time is 9999 hours 59 minutes 59 seconds. The hours count resets when **RESET** is pushed, an RS-232 or RS-485 clear is executed or on loss of power. Press **TOTAL/TIMER** to show this as the primary display.

PEAK (Meters Only): PEAK will display the most recent peak flow rate until totalizer is reset.

SETPT (Controllers Only): Pushing SETPT will allow you to change the controller's set-point.

RESET – The counter can be reset to zero at any time by pushing the RESET button. To clear the counter via RS-232 or RS-485, establish serial communication with the meter or controller as described in the RS-232 or RS-485 section of the manual. To reset the counter, enter the following commands:

In Polling (addressable) Mode: Address\$\$T <Enter> (e.g. B\$\$T <Enter>)



WHEN USING A MASS FLOW CONTROLLER AS AN ABSOLUTE PRESSURE CONTROLLER, THE MASS FLOW RATE MAY MOMENTARILY EXCEED THE FLOW MEASUREMENT CAPABILITY (FULL SCALE + 28%) OF THE UNIT. THIS MAY OCCUR WHEN THE UNIT IS ASKED TO MAKE AN ABRUPT PRESSURE CHANGE.

IF THE TOTALIZER IS IN USE AT THAT TIME, THE TOTALIZED VALUE WILL NECESSARILY BECOME INCORRECT. PLEASE RESET THE TOTALIZER IF SUCH AN 'OVER-FLOW' CONDITION HAS OCCURRED.

BATCH PROCESSING MODE – CONTROLLERS ONLY

Batch mode is a function within the optional Totalizing mode. Batch mode is designed to provide repeatable, finite flow quantities.

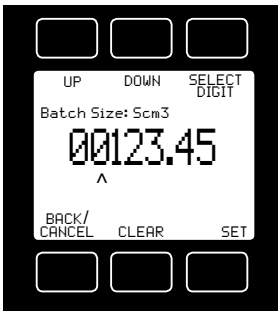

To activate Batch Mode: Press **BATCH**. Then use **SELECT DIGIT** to move the arrow to the desired digit, and the UP and DOWN buttons to change the value. Press **CLEAR** to return to zero. Press **SET** to record your value. If the controller has a non-zero Set-Point, flow will start immediately. If not, press **SETPT** to select a Set-Point.

Batch values can also be established via RS-232/RS-485 communication using Register 92. (See RS-232/RS-485 Section of this manual for serial communication methods.)

Note: While the Totalizer counter will still reset across power cycles, the Batch process value is stored in EEPROM and will remain valid until updated by the user.

While the Batch is processing, the remaining amount of the Batch value is displayed above **REMAIN** on the Totalizer screen. Time elapsed during the Batch processing is displayed below the totalizing counter. Press **TOTAL/TIMER** to toggle these values.

When the active Totalizer reaches the preset Batch value, flow ceases, and **REMAIN** updates to **Done Batch**. The Totalizer timer also pauses.



- **To start a new batch of the same size**, simply press RESET. The Totalizer can reproduce any number of fixed Batches in this manner.

- **To start a smaller batch**, decrease the Batch value. The new batch begins when you press RESET.

- **To continue the existing batch to a larger total volume**, increase the Batch value. Flow resumes as soon as you press OK in the Batch Value screen.

- **To start a larger batch from scratch**, first clear the flow Set-Point to zero to prevent unwanted flow.

Then increase the Batch value, and select a flow Set-Point. Flow will begin when you press **SET** in the Set-Point screen.

- **To cancel a batch in progress**, clear the Set-Point and press **SET**.

Note: Batch mode operates independently of the desired flow rate, but requires a non-zero flow rate to run. The rate of flow is determined by the controller Set-Point value, which is established by the user via analog, front panel or serial communication methods. Batches can be produced more slowly or more rapidly as determined by the user-selected Set-Point flow rate.

To turn off Batch Mode: Set the Batch value to zero (0.0) via the front panel or RS-232/RS-485 communication using Register 92. If there is a non-zero flow Set-Point, flow will immediately resume, and the Totalizer counter will continue per the user established Set-Point flow rate.

Portable Meters and Gauges

Rechargeable Flow Meters and Pressure Gauges use a Li-Ion 3.7V cell located in the top section of the device. **The Li-Ion cell must not be removed.**

Normal battery life of a fully-charged cell is 18 hours with a monochrome display or 5 hours with a TFT color display, when the backlight is set to 10. Dimming the backlight will increase battery life.

The battery can be charged through either the micro-USB port or the mini-DIN connector. When the device is connected to external power it will function normally while the battery is charging. **Note: If the battery has no charge, a charge time of one minute will be required before the unit can be turned on.** Charge rates will be fastest through the micro-USB port using the included power supply or equivalent. The device will charge fastest when it is turned off.

Recharge Time: 3.5 hours with 2A USB supply. The micro-USB port is for charging purposes only.

The green/red indicator LED on top of the device will light up green to indicate that the unit is charging. The green LED will turn off when the battery is charged and the power switch is turned to "I" for ON.

A small lightning bolt symbol will display next to the battery symbol while the device is charging. It will no longer appear when the device is fully charged.

The indicator LED flashes red when the device has about 1 hour of battery life remaining. The LED will flash red at a faster rate when the device has about 15 minutes of battery life remaining. It is highly recommended that the device be charged immediately. When the battery charge runs out, the display contrast will turn to 0 and device performance is no longer guaranteed.

 Output signals from the meter are passed through the mini-DIN connector on top of the device. Rechargeable battery units do not support 0-10V analog output. Receiver resistance must be below 250Ω.

Turn the power switch on top of the device to "O" for OFF when it is not in use.

 **Warning:** If the device is left ON until the battery can no longer power it, the charge indicator will fall out of sync with the actual charge. The device can be re-synced by fully charging the battery once.

A Battery Charge Indicator appears below Tare on the display.

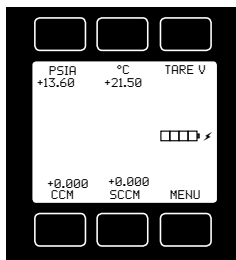

TOP VIEW OF DEVICE

Green = Charging
Flashing Red = Low Battery

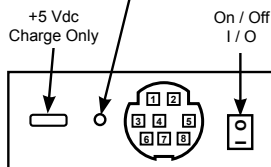

CAUTION! DO NOT OPERATE OR STORE THE DEVICE OUTSIDE OF THE -10° TO +50°C TEMPERATURE RANGE. IF INTERNAL SENSORS DETECT THAT THE TEMPERATURE IS OUTSIDE OF THIS RANGE, THE DISPLAY CONTRAST WILL TURN TO 0 AND THE METER'S PERFORMANCE IS NO LONGER GUARANTEED.

THE SAFE CHARGING TEMPERATURE RANGE IS 0° TO +45°C. IF INTERNAL SENSORS DETECT TEMPERATURES OUTSIDE OF THIS RANGE, THE BATTERY WILL NOT CHARGE.

Pressure Menu for Portable Meters

portable meters are programmed with additional pressure read options. Pressing the pressure button once (upper left) will move the pressure reading to the main display. Pressing the button a second time will open a menu of pressure read options. Scroll **UP** or **Down** and press **Select** to make a change.



When the pressure button is already using the device engineering units, the bottom menu option displays as **“Set device eng units”**.

When the pressure button is using something different than device engineering units (e.g., bar instead of PSI), the bottom menu option displays as **“Show device units”**.

The serial data line changes only when device engineering units are changed, and the instrument will prompt you to accept these changes to the serial line.

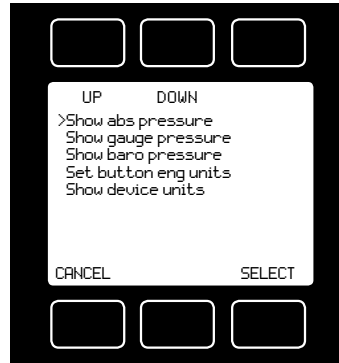
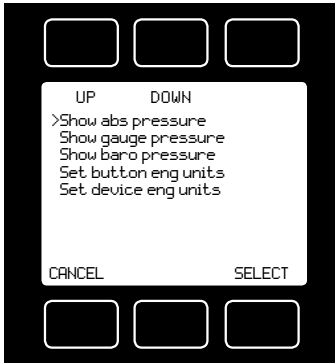

TARE P w/BARO: The stream absolute pressure sensor can be tared to the barometric pressure sensor. In this case, the absolute pressure is offset by the differential between the two readings. **TARE P w/BARO** can be accessed from the **MISC2** display.

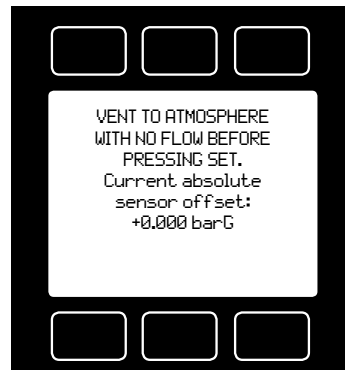
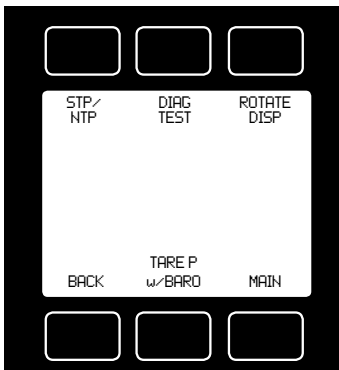

Accessory: Multi-Drop Box



The **Multi-Drop Box** makes it convenient to wire multiple flow and/or pressure devices to a single RS-232 or RS-485 port. **Now available with a USB interface!**

The Multi-Drop Box has nine 8 pin mini-DIN ports available. The ports are to be used with a standard double ended 8 pin mini-DIN (DC-62) style cable going from the box to each flow or pressure device.

A single DB9 D-SUB type connector (COM PORT) connects, using the included cable, to the serial connector on a PC or laptop.

All of the flow and/or pressure devices are powered via a terminal block on the front of the box.

If more than nine devices will be required, additional Multi-Drop Boxes can be daisy chained together with a double ended 8 pin mini-DIN cable plugged into any receptacle on both boxes.

Multi-Drop Box Power Supply for Large Valve Controllers: The PS24VHC (Power Supply 24Vdc High Current) is a 6.5Amp 24Vdc power supply designed for running multiple large controllers on a Multi-Drop Box.

The 6.5Amp power supply can run as many as 8 large valve controllers, which makes it ideal for the Multi-Drop Box and multiple large valve (or small valve / large valve combination) controllers on a Multi-Drop Box.

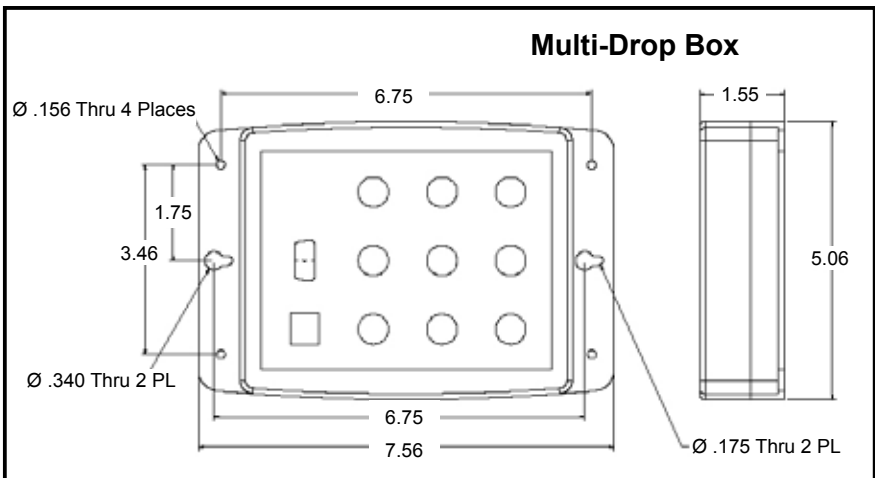

Accessory: Flow Vision™ SC Software

Flow Vision™ SC is an intuitive software interface to help your test cycles run smoother and shorten your engineering time!

Flow Vision™ SC lets you connect to and communicate with multiple L-Series units simultaneously. Now you can view virtual displays, control tabs, charts and data lines from every connected device on the same screen.

Flow Vision™ SC supports all RS-232 and RS-485 Serial communication functions, including: **gas selection, taring, set-point control, valve tuning and flow averaging.**

Session Saving: Save and reload your configuration data with confidence.

Script Building: Create scripts to adjust a controller's set-point value at variable specified time intervals.

Charting: Chart as many parameters as you want off as many devices as you want, with color coding, zooming, and printing functionality.

Alarms: Create software alarms that will notify you of given parameter conditions.

Data Capture & Logging: Capture and log data to either a .csv file or a .txt file. Improved Data Logging and Data Log File Splitting for easy to manage data.

Accessory: Flow Vision™ MX Software

Flow Vision™ MX software gives you an easy way to do **GAS BLENDING** using **LC Mass Flow Controllers** and your own PC.

Flow Vision™ MX software is a simple way to connect up to six mass flow controllers and create your own gas mix concentrations.

Using our inexpensive **Multi-Drop Box** and a single USB connection you can:

- **Create** your own gas blends
- **Adjust** flow rates
- **Save** your specific blend formulas.

All the controllers can be powered through the Multi-Drop Box-USB with a single power supply.

Just connect your unique gases to each controller, select the gas type either locally on the controller or through Flow Vision™ MX, manifold the flow outputs and create your gas mix.

Accessories

Description
Flow Vision™ SC software for interface with all MC-Series instruments
Flow Vision™ MX software for gas blending
9 position Multi Drop Box with 9-pin serial port and USB to PC
9 position Multi-Drop Box, Industrial connectors
9 position Multi Drop Box with serial port only
9 position Multi-Drop Box, industrial connectors, serial port only
Universal 100-240 VAC to 24 Volt DC Power Supply Adapter
High current power supply for Multi Drop Box use with Large Valve Controllers
micro-USB to wall adapter
Industrial carry and storage case for up to 2 portable meters/gauges
Industrial carry and storage case for up to 6 meters and controllers
8 Pin Male Mini-DIN connector cable, single ended, 6 foot length
8 Pin Male Right Angle Mini-DIN Cable, single ended, 6 foot length
8 Pin Male Mini-DIN connector cable, single ended, 25 foot length
8 Pin Male Mini-DIN connector cable, single ended, 50 foot length
8 Pin Male Mini-DIN connector cable, single ended, 75 foot length
8 Pin Male Mini-DIN connector cable, single ended, 100 foot length
8-pin Male Mini-DIN connector cable, double ended, no analog, 3 foot length
8-pin Male Mini-DIN connector cable, double ended, no analog, 6 foot length
8 Pin Male Mini-DIN connector cable, double ended, 6 foot length
8 Pin Male Mini-DIN connector cable, double ended, 25 foot length
8 Pin Male Mini-DIN connector cable, double ended, 50 foot length
8 Pin Male Mini-DIN to DB9 Female Adapter, 6 foot length
DB15 cable, single ended, 25 foot length
DB9 cable, double-ended female, 3 meter length
Industrial cable, 6 Pin, single ended, 10 foot length
Industrial cable, 6 Pin, single ended, 20 foot length
Industrial cable, 6 Pin, single ended, 50 foot length
Industrial cable, 6 pin double ended, 10 foot length
RS-232 to USB Converter

Accessories

MNPT to Compression Fittings	
10-32 - 1/8"	SS-200-1-0157
10-32 - 1/4"	SS-400-1-0256
1/8" - 1/8"	SS-200-1-2
1/8" - 1/4"	SS-400-1-2
1/8" - 3/8"	SS-600-1-2
1/8" - 1/2"	SS-810-1-2
1/8" - 3mm	SS-3M0-1-2
1/8" - 4mm	SS-4M0-1-2
1/8" - 6mm	SS-6M0-1-2
1/8" - 8mm	SS-8M0-1-2
1/8" - 12mm	SS-12M0-1-2
1/4" - 1/8"	SS-200-1-4
1/4" - 1/4"	SS-400-1-4
1/4" - 3/8"	SS-600-1-4
1/4" - 1/2"	SS-810-1-4
1/4" - 3mm	SS-3M0-1-4
1/4" - 4mm	SS-4M0-1-4
1/4" - 6mm	SS-6M0-1-4
1/4" - 8mm	SS-8M0-1-4
1/4" - 12mm	SS-12M0-1-4
1/2" - 1/8"	SS-200-1-8
1/2" - 1/4"	SS-400-1-8
1/2" - 3/8"	SS-600-1-8
1/2" - 1/2"	SS-810-1-8
1/2" - 3/4"	SS-1210-1-8
1/2" - 6mm	SS-6M0-1-8
1/2" - 8mm	SS-8M0-1-8
1/2" - 12mm	SS-12M0-1-8
1/2" - 16mm	SS-16M0-1-8
3/4" - 1/4"	SS-400-1-12
3/4" - 1/2"	SS-810-1-12
3/4" - 3/4"	SS-1210-1-12
3/4" - 12mm	SS-12M0-1-12
3/4" - 16mm	SS-16M0-1-12

Filters & Elements FNPT-MNPT	
10-32 5μ	510053
10-32 20μ	510054
1/8" 20μ	ILF-1/8-20
1/4" 40μ	ILF-1/4-40
1/2" 40μ	ILF-1/2-40*
3/4" 40μ	ILF-3/4-40*
20μ element	ILFE20
40μ element	ILFE40
40μ element	ILFE40L*

Filters & Elements FNPT-FNPT*	
10-32 5μ	CF-303-20-316
*requires MNPT to MNPT coupler to interface with L-Series flow bodies	

10-32 Male UNF to 1/8 FNPT Adapter	
410133	
Male M5 (10-32) Buna-N O-ring face seal to 1/8" Female NPT	

Technical Data for L - Series Water Flow Meters

0 – 0.5 ccm Full Scale through 0 – 10 lpm Full Scale

L-Series water flow meters read both water flow and water temperature. An optional pressure sensor is also available.

Standard Specifications (Contact Your dealer for available options.)

Performance	L Meters
Available Ranges	0.5 ccm to 10 lpm
Accuracy at calibration conditions after tare	± 2% Full Scale
Repeatability	± 2% Full Scale
Zero Shift and Span Shift	0.02% Full Scale / °Celsius / Atm
Operating Range / Turndown Ratio	2% to 100% Full Scale / 50:1 Turndown
Maximum Flow Rate	128% FS Measurable
Typical Response Time	20 ms (Adjustable)
Warm-up Time	< 1 Second

Operating Conditions	L Meters
Operating Temperature	+10 to +50 °Celsius
Maximum Pressure	200 psig
Mounting Attitude Sensitivity	None
Ingress Protection	IP40
Wetted Materials	302 & 303 Stainless Steel, 316L Stainless Steel, Viton®. If your application demands a different material, please contact Your dealer.

Communication / Power	L Meters
Monochrome LCD or Color TFT Display with integrated touchpad	Simultaneously displays Flow and Temperature (optional Pressure sensor available)
Digital Output Signal ¹ Options	RS-232 Serial / RS-485 Serial / PROFIBUS ³
Analog Output Signal ² Options	0-5 Vdc / 1-5 Vdc / 0-10 Vdc / 4-20 mA
Optional Secondary Analog Output Signal ²	0-5 Vdc / 1-5 Vdc / 0-10 Vdc / 4-20 mA
Electrical Connection Options	8 Pin Mini-DIN / 9-pin D-sub (DB9) / 15-pin D-sub (DB15) / 6 pin locking
Supply Voltage	7-30 Vdc (15-30 Vdc for 4-20 mA outputs)
Supply Current	0.040 Amp

1. The **Digital Output Signal** communicates Flow and Temperature (optional Pressure sensor available)
2. The **Analog Output Signal** and **Optional Secondary Analog Output Signal** communicate your choice of Flow or Temperature
3. If selecting **PROFIBUS**, no analog signal is available. PROFIBUS units do not have the display. See PROFIBUS specifications for PROFIBUS supply voltages and currents.

Range Specific Specifications

L Meters Full Scale Flow	Pressure Drop ¹ at FS Flow (PSID)	Mechanical Dimensions	Process Connections ²
0.5 ccm to 1 ccm	2.0	4.4"H x 2.4"W x 1.1"D	M5 (10-32) Female Thread
2 ccm to 500 ccm	2.0	4.6"H x 2.4"W x 1.1"D	1/8" NPT Female
1 lpm	4.0		
2 lpm	4.0	4.7"H x 2.7"W x 1.1"D	1/4" NPT Female
5 lpm	10.0	5.1"H x 4.0"W x 1.6"D	1/4" NPT Female
10 lpm	20.0		

1. Lower Pressure Drops Available, please contact Your dealer.
2. Compatible with Swagelok® tube, Parker®, face seal, push connect and compression adapter fittings. VCR and SAE connections upon request.

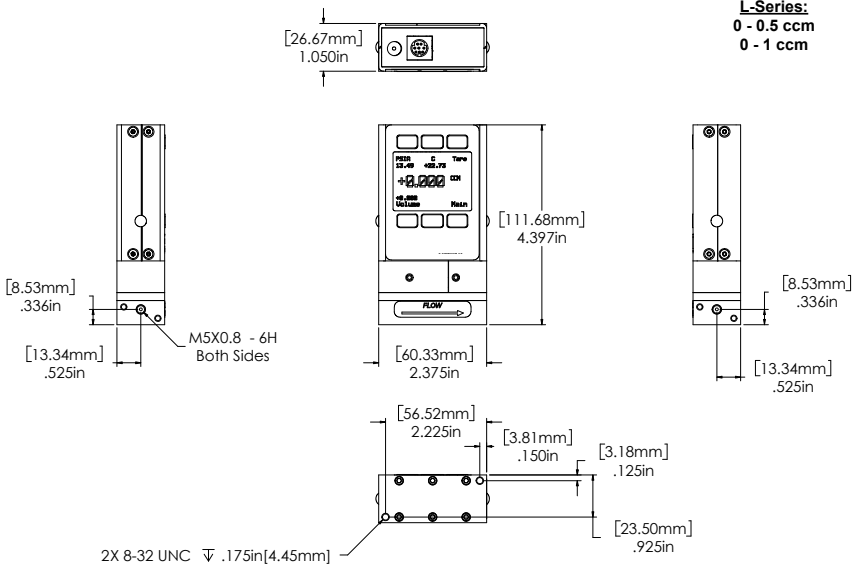

0.5 ccm to 1 ccm approximate shipping weight: 1.0 lb

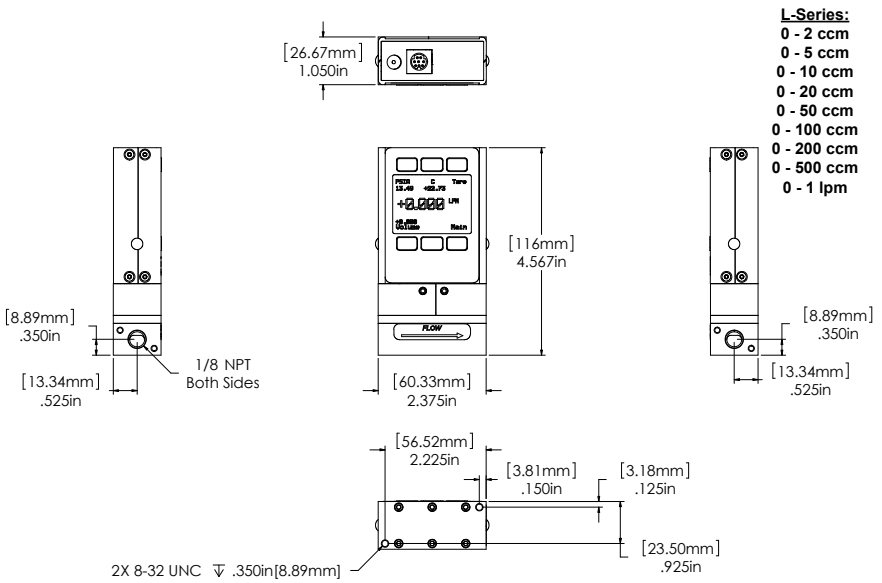

10 ccm to 1 lpm approximate shipping weight: 1.2 lb

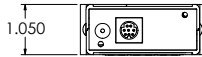

**L-Series:
0 - 2 lpm**

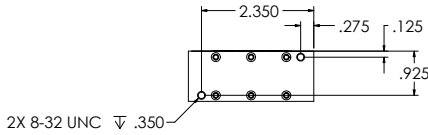
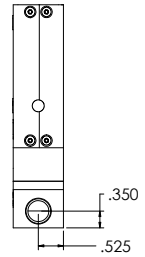
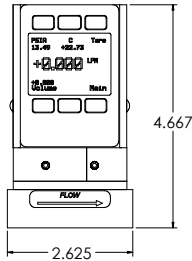
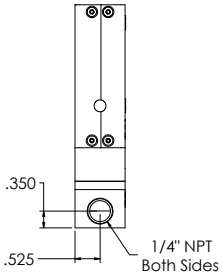

2 lpm approximate shipping weight: 1.5 lb

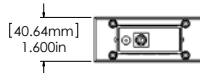

**L-Series:
0 - 5 lpm
0 - 10 lpm**

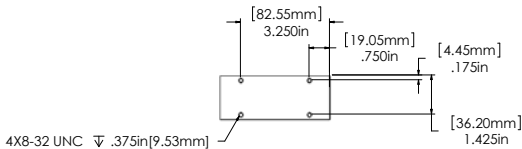
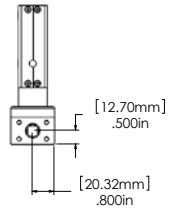
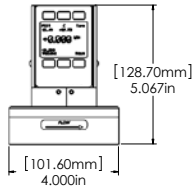
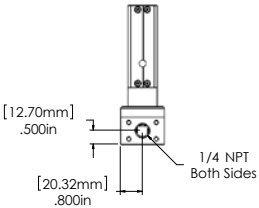

5 lpm to 10 lpm approximate shipping weight: 2.6 lb

Technical Data for LC & LCR Water Flow Controllers

0 – 0.5 ccm Full Scale through 0 – 5 lpm Full Scale

LC and LCR-Series water flow controllers display both water flow and water temperature. An optional pressure sensor is also available.

Standard Specifications (Contact Your dealer for available options.)

Performance	LC Controllers	LCR Controllers
Available Ranges	0.5 ccm to 500 ccm	1 lpm to 5 lpm
Accuracy at calibration conditions after tare	± 2% Full Scale	
Repeatability	± 2% Full Scale	
Zero Shift and Span Shift	0.02% Full Scale / °Celsius / Atm	
Operating Range / Turndown Ratio	2% to 100% Full Scale / 50:1 Turndown	
Maximum Flow Rate	102.4% FS Controllable	
Typical Response Time	100 ms (Adjustable)	
Warm-up Time	< 1 Second	

Operating Conditions	LC Controllers	LCR Controllers
Operating Temperature	+10 to +50 °Celsius	
Maximum Pressure	150 psig	
Mounting Attitude Sensitivity	None	Mount with valve cylinder vertical & upright
Valve Type	Normally Closed	
Ingress Protection	IP40	
Wetted Materials	LC, LCR: 430FR Stainless Steel, 302 & 303 Stainless Steel, 316L Stainless Steel, Viton®, FFKM. LCR Controllers Add 416 Stainless Steel, Delrin®. If your application demands a different material, please contact Your dealer.	

Communication / Power	LC Controllers	LCR Controllers
Monochrome LCD or Color TFT Display with integrated touchpad	Simultaneously displays Flow and Temperature (optional Pressure sensor available)	
Digital Output Signal ¹ Options	RS-232 Serial / RS-485 Serial / PROFIBUS ³	
Analog Output Signal ² Options	0-5 Vdc / 1-5 Vdc / 0-10 Vdc / 4-20 mA	
Optional Secondary Analog Output Signal ²	0-5 Vdc / 1-5 Vdc / 0-10 Vdc / 4-20 mA	
Electrical Connection Options	8 Pin Mini-DIN / 9-pin D-sub (DB9) / 15-pin D-sub (DB15) / 6 pin locking	
Supply Voltage	12-30 Vdc (15-30 Vdc for 4-20 mA outputs)	24-30 Vdc
Supply Current	0.250 Amp	0.750 Amp

1. The **Digital Output Signal** communicates Flow and Temperature (optional Pressure sensor available)
2. The **Analog Output Signal** and **Optional Secondary Analog Output Signal** communicate your choice of Flow or Temperature
3. If selecting **PROFIBUS**, no analog signal is available. PROFIBUS units do not have the display. See PROFIBUS specifications for PROFIBUS supply voltages and currents.

Range Specific Specifications

Full Scale Flow	Pressure Drop ¹ at FS Flow (PSID)	Mechanical Dimensions	Process Connections ²
LC Controllers			
0.5 ccm to 1 ccm		4.4"H x 3.4"W x 1.1"D	M5 (10-32) Female Thread
2 ccm		4.6"H x 3.6"W x 1.1"D	
5 ccm to 50 ccm	5.0		
100 ccm	5.0		
200 ccm to 500 ccm	7.5		1/8" NPT Female
LCR Controllers			
1 lpm	4.0	5.7"H x 7.7"W x 2.3"D	1/4"NPT Female
2 lpm	4.0		
5 lpm	10.0		

1. Lower Pressure Drops Available, please contact Your dealer.
2. Compatible with Swagelok® tube, Parker®, face seal, push connect and compression adapter fittings. VCR and SAE connections upon request.

LC-Series
 0 - 0.5 ccm
 0 - 1 ccm

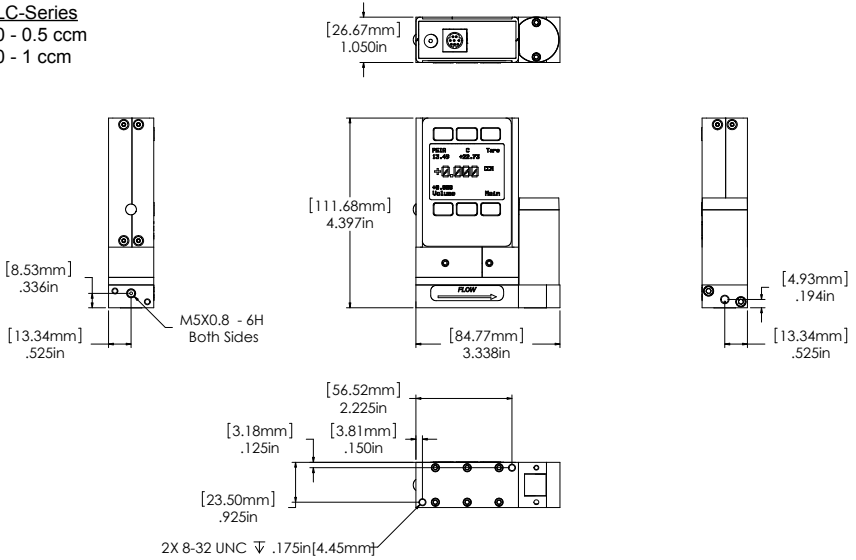

0.5 ccm to 1 ccm approximate shipping weight: 1.1 lb.

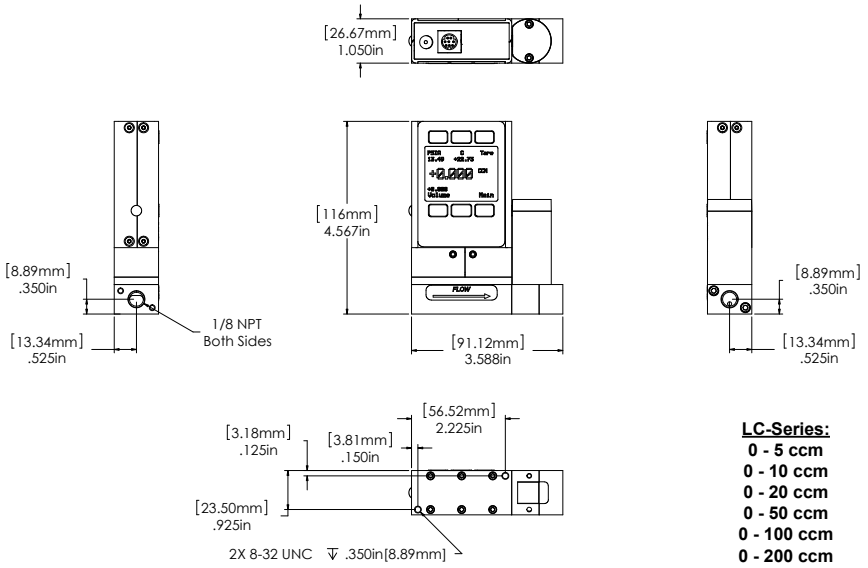

LC-Series:
 0 - 5 ccm
 0 - 10 ccm
 0 - 20 ccm
 0 - 50 ccm
 0 - 100 ccm
 0 - 200 ccm
 0 - 500 ccm

100 ccm to 500 ccm approximate weight: 1.6 lb

LCR-Series:

0 - 1 lpm

0 - 2 lpm

0 - 5 lpm

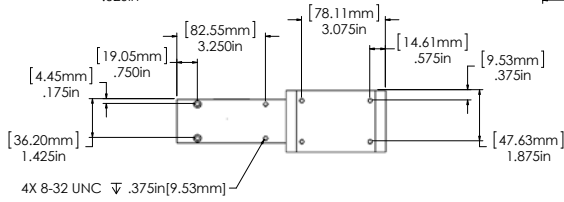
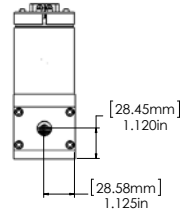
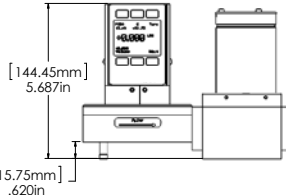
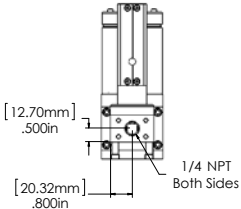
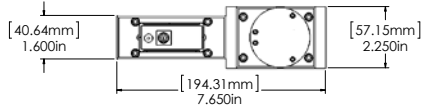

1 lpm to 5 lpm approximate weight: 9.0 lb.

Technical Data for PROFIBUS Meters, Gauges and Controllers

NOTICE: The following specifications are applicable to PROFIBUS enabled meters, gauges and controllers only.

All other operating specifications are shown in the Technical Data page for standard instruments.

All standard device features and functions are available and operate in accordance with the standard device operating manual provided with the device.

Specification	Meter or Gauge	Small Valve Controller	Large Valve Controller	Description
Input /Output Signal Digital				PROFIBUS DP
Electrical Connections	DB9			
Supply Voltage:	7 to 30 Vdc	12 to 30 Vdc	24 to 30 Vdc	
Supply Current	80mA @ 12Vdc 65mA @ 24Vdc	295mA @ 12Vdc 280mA @ 24Vdc	780mA @ 24Vdc	

Power and Signal Connections:

Connect to the device using two DB9 connectors.

The female top connection is PROFIBUS.

The male connection on the side is power and RS-232 or RS-485.

Pin out diagrams for all PROFIBUS enabled devices are shown:

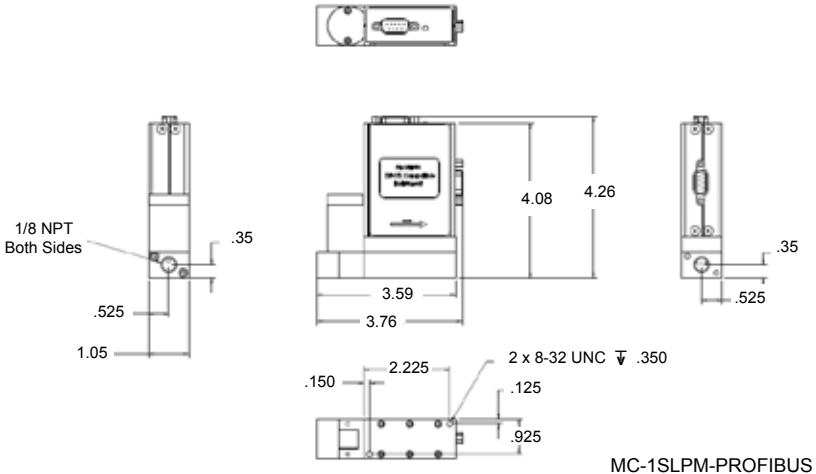
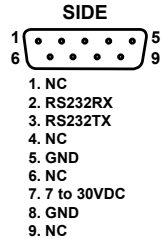
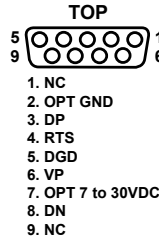

PROFIBUS MC1SLPM shown to provide PROFIBUS connector dimensions only. Flow body and valve dimensions will vary with range. Please see the device specifications for complete dimensions.

PROFIBUS units do not have a display screen.

Eight Pin Mini-DIN Connector Pin-Outs

If your instrument was ordered with the standard Eight Pin Mini-DIN connection, please be sure to reference the following pin-out diagram.

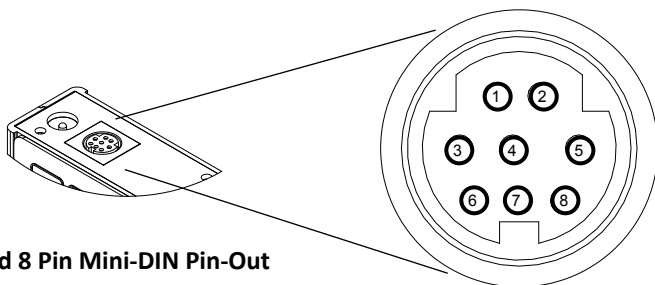

Standard 8 Pin Mini-DIN Pin-Out

Pin	Function	Mini-DIN cable color
1	Inactive (or optional 4-20mA Primary Output Signal)	Black
2	Static 5.12 Vdc [or optional Secondary Analog Output (4-20mA, 5Vdc, 10Vdc) or Basic Alarm]	Brown
3	Serial RS-232RX / RS-485(-) Input Signal (receive)	Red
4	Meters/Gauges = Remote Tare (Ground to Tare) Controllers = Analog Set-Point Input	Orange
5	Serial RS-232TX / RS-485(+) Output Signal (send)	Yellow
6	0-5 Vdc (or optional 0-10 Vdc) Output Signal	Green
7	Power In (as described above)	Blue
8	Ground (common for power, digital communications, analog signals and alarms)	Purple

Note: The above pin-out is applicable to all the flow meters and controllers with the Mini-DIN connector. The availability of different output signals depends on the options ordered. Optional configurations are noted on the unit's calibration sheet.

Locking Industrial Connector Pin-Outs

If your instrument was ordered with a Six Pin Locking Industrial connection, please be sure to reference the following pin-out diagram.

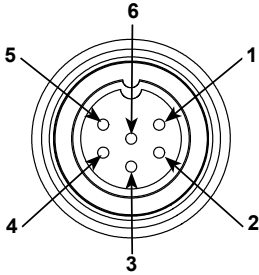

Male Connector: Cable

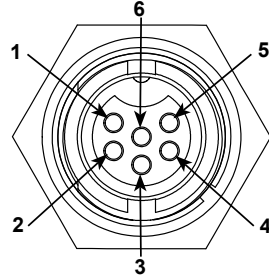

Female Connector: Device

Pin	Function
1	Power In (+)
2	RS-232TX / RS-485(+)
3	RS-232RX / RS-485(-)
4	Meters/Gauges = Remote Tare (Ground to Tare) Controllers = Analog Set-Point Input
5	Ground (common for power, communications and signals)
6	Signal Out (Voltage or Current as ordered)



The above pin-out is applicable to all the flow meters and controllers ordered with the industrial connector. The availability of different output signals depends on the flow meter options ordered.



If your instrument was ordered with a DB9 connection, be sure to check the Calibration Label on the device and reference the appropriate pin-out diagram.

Standard DB9 Pin-out

The following pin-out chart describes the safest and generally compatible arrangement when connecting a non-M-Series wire to a DB9 equipped M-Series. Not all features may be available between brands, but the common denominators are featured in our DB9 offerings, along with some options for customization.

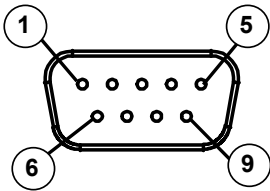

Male Connector Front View

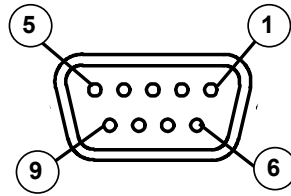

Female Connector Front View

Pin	Function
1	Not Connected (4-20mA analog output signal optional)
2	5.12 Vdc or (secondary analog output (4-20mA, 5Vdc, 10Vdc or alarm optional)
3	Serial RS-232RX or RS-485(-)
4	Analog Input Signal [4-20mA, 5Vdc, or 10Vdc] (short to ground for remote tare function on non-controllers)
5	Serial RS-232TX or RS-485(+)
6	0-5 Vdc Output Signal (or 0-10 Vdc optional)
7	Power In (+Vdc)
8	Ground (common for power, digital communications, analog signals and alarms)
9	Ground (common for power, digital communications, analog signals and alarms)

Note: The above pin-out is applicable to all the flow meters and controllers with the DB9 connector. The availability of different output signals depends on the options ordered. Optional configurations are noted on the unit's calibration sheet.



Do not connect RS-485 to RS-232 units or cables. Damage will occur! Check part number or contact factory to verify RS-485 functionality.



Due to variance in cable manufacturing, please identify proper wiring/pins via continuity check & color when using blunt cut multi-strand cables.



If your instrument was ordered with a DB9 connection, be sure to check the Calibration Label on the device and reference the appropriate pin-out diagram.

DB9A / DB9K Pin-out

The following pin-out chart describes the safest and generally compatible arrangement when connecting a non-MC-Series DB9 wire to a **DB9A** or **DB9K** equipped MC-Series. Not all features may be available between brands, but the common denominators are featured in our DB9A or DB9K offerings, along with some options for customization.

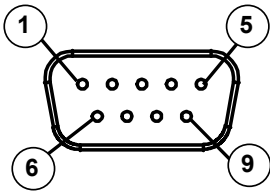

Male Connector Front View

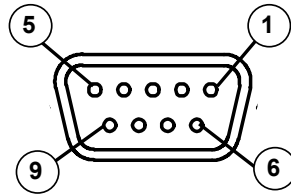

Female Connector Front View

Pin	Function
1	Not Connected
2	0-5 Vdc Output Signal (or 0-10 Vdc optional)
3	Power In (+Vdc)
4	Ground (common for power, digital communications, analog signals and alarms)
5	Serial RS-232TX or RS-485 (+)
6	Analog Input Signal [4-20mA, 5Vdc, or 10Vdc] (short to ground for remote tare function on non-controllers)
7	Ground (common for power, digital communications, analog signals and alarms)
8	Ground (common for power, digital communications, analog signals and alarms)
9	Serial RS-232RX or RS-485 (-)

Note: The above pin-out is applicable to all the flow meters and controllers with the **DB9A** or **DB9K** connector. The availability of different output signals depends on the options ordered. Optional configurations are noted on the unit's calibration sheet.



Do not connect RS-485 to RS-232 units or cables. Damage will occur! Check part number or contact factory to verify RS-485 functionality.



Due to variance in cable manufacturing, please identify proper wiring/pins via continuity check & color when using blunt cut multi-strand cables.



If your instrument was ordered with a DB9 connection, be sure to check the Calibration Label on the device and reference the appropriate pin-out diagram.

DB9N Pin-out

The following pin-out chart describes the safest and generally compatible arrangement when connecting a non-L-Series wire to a **DB9N** equipped L-Series. Not all features may be available between brands, but the common denominators are featured in our DB9N offerings, along with some options for customization.

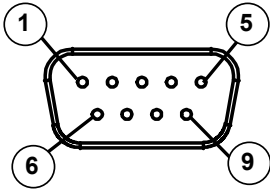

Male Connector Front View

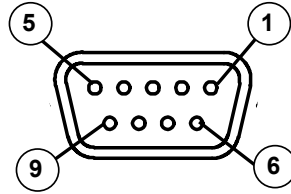

Female Connector Front View

Pin	Function
1	Power In (+Vdc)
2	Analog Input Signal [4-20mA, 5Vdc, or 10Vdc] (short to ground for remote tare function on non-controllers)
3	0-5 Vdc Output Signal (or 0-10 Vdc optional)
4	Not Connected
5	Ground (common for power, digital communications, analog signals and alarms)
6	Ground (common for power, digital communications, analog signals and alarms)
7	Serial RS-232RX or RS-485 (-)
8	Serial RS-232TX or RS-485 (+)
9	Not Connected
<p>Note: The above pin-out is applicable to all the flow meters and controllers with the DB9N connector. The availability of different output signals depends on the options ordered. Optional configurations are noted on the unit's calibration sheet.</p>	



Do not connect RS-485 to RS-232 units or cables. Damage will occur! Check part number or contact factory to verify RS-485 functionality.



Due to variance in cable manufacturing, please identify proper wiring/pins via continuity check & color when using blunt cut multi-strand cables.



If your instrument was ordered with a DB9 connection, be sure to check the Calibration Label on the device and reference the appropriate pin-out diagram.

DB9R Pin-out

The following pin-out chart describes the safest and generally compatible arrangement when connecting a non-L-Series DB9 wire to a **DB9R** equipped L-Series. Not all features may be available between brands, but the common denominators are featured in our DB9R offerings, along with some options for customization.

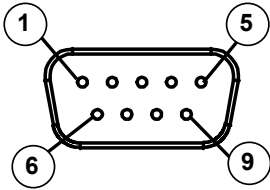

Male Connector Front View

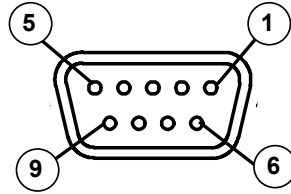

Female Connector Front View

Pin	Function
1	Serial RS-232TX or RS-485 (+)
2	0-5 Vdc Output Signal (or 0-10 Vdc optional)
3	Analog Input Signal [4-20mA, 5Vdc, or 10Vdc] (short to ground for remote tare function on non-controllers)
4	Ground (common for power, digital communications, analog signals and alarms)
5	Not Connected
6	Serial RS-232RX or RS-485 (-)
7	Power In (+Vdc)
8	Ground (common for power, digital communications, analog signals and alarms)
9	Ground (common for power, digital communications, analog signals and alarms)

Note: The above pin-out is applicable to all the flow meters and controllers with the **DB9R** connector. The availability of different output signals depends on the options ordered. Optional configurations are noted on the unit's calibration sheet.



Do not connect RS-485 to RS-232 units or cables. Damage will occur! Check part number or contact factory to verify RS-485 functionality.



Due to variance in cable manufacturing, please identify proper wiring/pins via continuity check & color when using blunt cut multi-strand cables.



If your instrument was ordered with a DB9 connection, be sure to check the Calibration Label on the device and reference the appropriate pin-out diagram.

DB9T Pin-out

The following pin-out chart describes the safest and generally compatible arrangement when connecting a non-L-Series wire to a **DB9T** equipped L-Series. Not all features may be available between brands, but the common denominators are featured in our DB9T offerings, along with some options for customization.

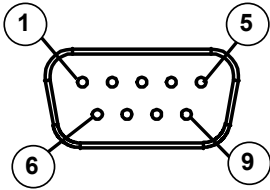

Male Connector Front View

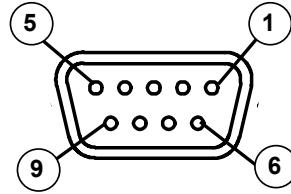

Female Connector Front View

Pin	Function
1	Serial RS-232TX or RS-485 (+)
2	0-5 Vdc Output Signal (or 0-10 Vdc optional)
3	Power In (+Vdc)
4	Ground (common for power, digital communications, analog signals and alarms)
5	Not Connected
6	Analog Input Signal [4-20mA, 5Vdc, or 10Vdc] (short to ground for remote tare function on non-controllers)
7	Ground (common for power, digital communications, analog signals and alarms)
8	Ground (common for power, digital communications, analog signals and alarms)
9	Serial RS-232RX or RS-485 (-)

Note: The above pin-out is applicable to all the flow meters and controllers with the **DB9T** connector. The availability of different output signals depends on the options ordered. Optional configurations are noted on the unit's calibration sheet.



Do not connect RS-485 to RS-232 units or cables. Damage will occur! Check part number or contact factory to verify RS-485 functionality.



Due to variance in cable manufacturing, please identify proper wiring/pins via continuity check & color when using blunt cut multi-strand cables.



If your instrument was ordered with a DB9 connection, be sure to check the Calibration Label on the device and reference the appropriate pin-out diagram.

DB9U Pin-out

The following pin-out chart describes the safest and generally compatible arrangement when connecting a non-L-Series wire to a DB9U equipped L-Series. Not all features may be available between brands, but the common denominators are featured in our DB9U offerings, along with some options for customization.

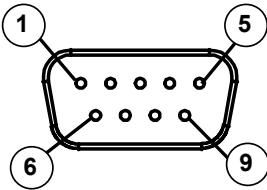

Male Connector Front View

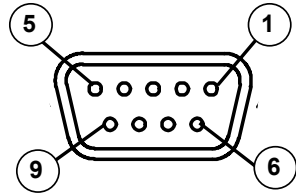

Female Connector Front View

Pin	Function
1	Serial RS-232RX or RS-485(-)
2	0-5 Vdc Output Signal (or 0-10 Vdc optional)
3	Power In (+Vdc)
4	Ground (common for power, digital communications, analog signals and alarms)
5	Not Connected
6	Analog Input Signal [4-20mA, 5Vdc, or 10Vdc] (short to ground for remote tare function on non-controllers)
7	Ground (common for power, digital communications, analog signals and alarms)
8	Ground (common for power, digital communications, analog signals and alarms)
9	Serial RS-232TX or RS-485(+)

Note: The above pin-out is applicable to all the flow meters and controllers with the **DB9U** connector. The availability of different output signals depends on the options ordered. Optional configurations are noted on the unit's calibration sheet.



Do not connect RS-485 to RS-232 units or cables. Damage will occur! Check part number or contact factory to verify RS-485 functionality.



Due to variance in cable manufacturing, please identify proper wiring/pins via continuity check & color when using blunt cut multi-strand cables.

DB15 Pin-Outs

If your instrument was ordered with a DB15 connection, be sure to check the Calibration Label on the device and reference the appropriate pin-out diagram.

The following pin-out chart describes the safest and generally compatible arrangement when connecting a non-M-Series DB15 wire to a DB15 equipped M-Series. Not all features may be available between brands, but the common denominators are featured in our DB15 offerings, along with some options for customization.

DB15 – Pin-Out Standard Style

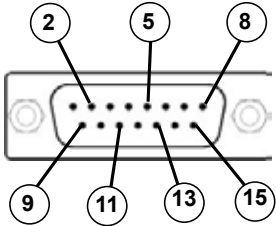

Male Connector Front View

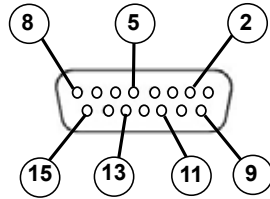

Female Connector Front View

Pin Number	Function
1	Ground
2	Primary Analog Signal Output
3	Ground
4	N/C
5	Power Supply (+Vdc)
6	N/C
7	N/C
8	Analog Tare (meters — when grounded) Analog Set-Point Input (controllers)
9	Power Supply Common
10	Ground
11	Secondary Analog Signal Output / fixed 5.12Vdc
12	N/C
13	RS-232 RX (receive) or RS-485 –
14	Ground
15	RS-232 TX (send) or RS-485 +

Check your device's calibration certificate and user manual for the actual electrical input/output requirements, as all instruments are custom configured to some extent.

NOTE: Pins 1, 3, 9, 10 and 14 are connected together inside of the device and are common grounding points.

N/C = Not Connected/Open (can be used for custom pin assignments – please consult factory).

DB15 Pin-Outs

If your instrument was ordered with a DB15 connection, be sure to check the Calibration Label on the device and reference the appropriate pin-out diagram.

The following pin-out chart describes the safest and generally compatible arrangement when connecting a non-M-Series DB15 wire to a **DB15A** equipped M-Series. Not all features may be available between brands, but the common denominators are featured in our DB15 offerings, along with some options for customization.

DB15A – Pin-Out “Aalborg XFM” Style

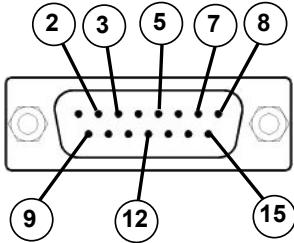

Male Connector Front View

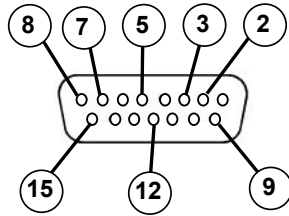

Female Connector Front View

Pin Number	Function
1	Ground
2	Primary Analog Signal Output
3	Analog Tare (meters — when grounded)* Analog Set-Point Input (controllers)*
4	Ground
5	Power Supply Common
6	Ground
7	Power Supply (+Vdc)
8	RS-232 Tx (send) / RS-485 –
9	Ground
10	N/C
11	N/C
12	Secondary Analog Signal Output / fixed 5.12Vdc*
13	N/C
14	N/C
15	RS-232 Rx (receive) / RS-485 +

Check your device's calibration certificate and user manual for the actual electrical input/output requirements, as all instruments are custom configured to some extent.

* Added to allow for full use of features on M-Series devices, may not be present on host wiring

NOTE: Pins 1, 4, 5, 6 and 9 are connected together inside of the device and are common grounding points.

N/C = Not Connected/Open (can be used for custom pin assignments – please consult factory).

DB15 Pin-Outs

If your instrument was ordered with a DB15 connection, be sure to check the Calibration Label on the device and reference the appropriate pin-out diagram.

The following pin-out chart describes the safest and generally compatible arrangement when connecting a non-M-Series DB15 wire to a **DB15B** equipped M-Series. Not all features may be available between brands, but the common denominators are featured in our DB15 offerings, along with some options for customization.

DB15B – Pin-Out “Brooks” Style

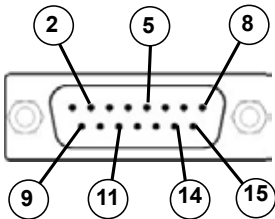

Male Connector Front View

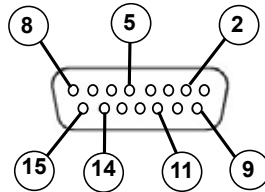

Female Connector Front View

Pin Number	Function
1	Ground
2	Primary Analog Signal Output
3	N/C
4	N/C
5	Power Supply (+Vdc)
6	N/C
7	N/C
8	Analog Tare (meters — when grounded)* Analog Set-Point Input (controllers)*
9	Power Supply Common
10	Ground
11	Secondary Analog Signal Output / fixed 5.12Vdc
12	N/C
13	N/C
14	RS-232 RX (receive) or RS-485 —*
15	RS-232 TX (send) or RS-485 +*

Check your device's calibration certificate and user manual for the actual electrical input/output requirements, as all instruments are custom configured to some extent.

NOTE: Pins 1, 9, and 10 are connected together inside of the device and are common grounding points.

N/C = Not Connected/Open (can be used for custom pin assignments – please consult factory).

* Added to allow for full use of features on M-Series devices, may not be present on host wiring

DB15 Pin-Outs

If your instrument was ordered with a DB15 connection, be sure to check the Calibration Label on the device and reference the appropriate pin-out diagram.

The following pin-out chart describes the safest and generally compatible arrangement when connecting a non-M-Series DB15 wire to a **DB15K** equipped M-Series. Not all features may be available between brands, but the common denominators are featured in our DB15 offerings, along with some options for customization.

DB15K – Pin-Out “MKS” Style

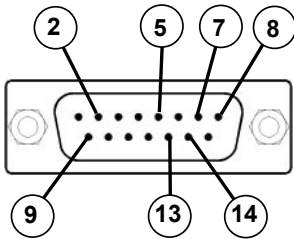

Male Connector Front View

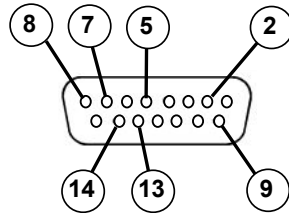

Female Connector Front View

Pin Number	Function
1	N/C
2	Primary Analog Signal Output
3	N/C
4	N/C
5	Power Supply Common
6	N/C
7	Power Supply (+Vdc)
8	Analog Tare (meters — when grounded) Analog Set-Point Input (controllers)
9	Secondary Analog Signal Output / fixed 5.12Vdc *
10	N/C
11	Ground
12	Ground
13	RS-232 RX (receive) or RS-485 – *
14	RS-232 TX (send) or RS-485 + *
15	Ground

Check your device's calibration certificate and user manual for the actual electrical input/output requirements, as all instruments are custom configured to some extent.

NOTE: Pins 5, 11, 12 and 15 are connected together inside of the device and are common grounding points.

N/C = Not Connected/Open (can be used for custom pin assignments – please consult factory).

* Added to allow for full use of features on M-Series devices, may not be present on host wiring.

DB15 Pin-Outs

If your instrument was ordered with a DB15 connection, be sure to check the Calibration Label on the device and reference the appropriate pin-out diagram.

The following pin-out chart describes the safest and generally compatible arrangement when connecting a non-M-Series DB15 wire to a **DB15H** equipped M-Series. Not all features may be available between brands, but the common denominators are featured in our DB15 offerings, along with some options for customization.

DB15H – Pin-Out “Hastings H” Style

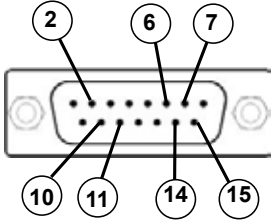

Male Connector Front View

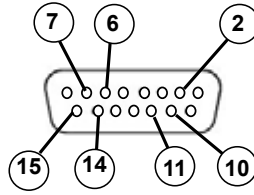

Female Connector Front View

Pin Number	Function
1	N/C
2	RS-232 RX (receive) or RS-485 – *
3	N/C
4	N/C
5	Ground
6	Primary Analog Signal Output
7	Power Supply Common
8	N/C
9	N/C
10	Secondary Analog Signal Output / fixed 5.12Vdc *
11	Power Supply (+Vdc)
12	Ground
13	N/C
14	Analog Tare (meters — when grounded) Analog Set-Point Input (controllers)
15	RS-232 TX (send) or RS-485 + *

Check your device's calibration certificate and user manual for the actual electrical input/output requirements, as all instruments are custom configured to some extent.

NOTE: Pins 5, 7 and 12 are connected together inside of the device and are common grounding points.

N/C = Not Connected/Open (can be used for custom pin assignments – please consult factory).

* Added to allow for full use of features on M-Series devices, may not be present on host wiring.

DB15 Pin-Outs

If your instrument was ordered with a DB15 connection, be sure to check the Calibration Label on the device and reference the appropriate pin-out diagram.

The following pin-out chart describes the safest and generally compatible arrangement when connecting a non-M-Series DB15 wire to a **DB15O** equipped M-Series. Not all features may be available between brands, but the common denominators are featured in our DB15 offerings, along with some options for customization.

DB15O – Pin-Out "Brooks" variant

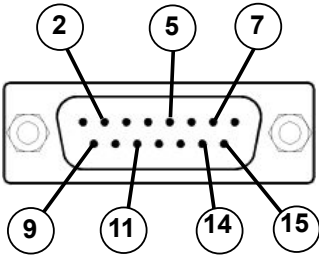

Male Connector Front View

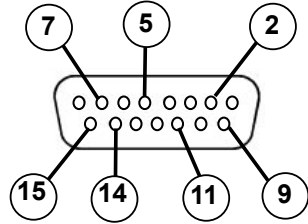

Female Connector Front View

Pin Number	Function
1	Ground
2	N/C
3	N/C
4	Primary Analog Signal Output
5	Power Supply (+Vdc)
6	N/C
7	Analog Tare (meters — when grounded)* Analog Set-Point Input (controllers)*
8	N/C
9	Power Supply Common
10	Ground
11	Secondary Analog Signal Output / fixed 5.12Vdc
12	N/C
13	N/C
14	RS-232 RX (receive) or RS-485 -*
15	RS-232 TX (send) or RS-485 +*

Check your device's calibration certificate and user manual for the actual electrical input/output requirements, as all instruments are custom configured to some extent.

NOTE: Pins 1, 9, and 10 are connected together inside of the device and are common grounding points.

N/C = Not Connected/Open (can be used for custom pin assignments – please consult factory).

* Added to allow for full use of features on M-Series devices, may not be present on host wiring

DB15 Pin-Outs

If your instrument was ordered with a DB15 connection, be sure to check the Calibration Label on the device and reference the appropriate pin-out diagram.

The following pin-out chart describes the safest and generally compatible arrangement when connecting a non-M-Series DB15 wire to a **DB15S** equipped M-Series. Not all features may be available between brands, but the common denominators are featured in our DB15 offerings, along with some options for customization.

DB15S – Pin-Out “Sierra” Style

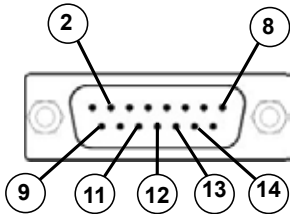

Male Connector Front View

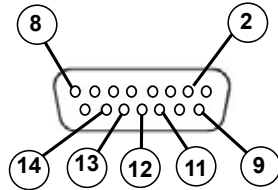

Female Connector Front View

Pin Number	Function
1	Ground
2	Primary Analog Signal Output
3	N/C
4	N/C
5	Ground
6	N/C
7	N/C
8	Analog Tare (meters — when grounded) Analog Set-Point Input (controllers)
9	Power Supply Common
10	Ground
11	Secondary Analog Signal Output / fixed 5.12Vdc *
12	RS-232 RX (receive) or RS-485 - *
13	Power Supply (+Vdc)
14	RS-232 TX (send) or RS-485 + *
15	Ground

Check your device's calibration certificate and user manual for the actual electrical input/output requirements, as all instruments are custom configured to some extent.

NOTE: Pins 1, 5, 9, 10 and 15 are connected together inside of the device and are common grounding points.

N/C = Not Connected/Open (can be used for custom pin assignments – please consult factory).

* Added to allow for full use of features on M-Series devices, may not be present on host wiring.

**Additional Information for
CSA and ATEX Approved Devices**



EEx nA IIC T4

Class I, Div. 2 Group A, B, C and D T4

24 Vdc, 0.800A max

Class I, Zone 2 AEx nA IIC T4



WARNINGS:

EXPLOSION HAZARD – DO NOT DISCONNECT WHILE CIRCUIT IS LIVE UNLESS AREA IS KNOWN TO BE NON-HAZARDOUS.

EXPLOSION HAZARD – SUBSTITUTION OF COMPONENTS MAY IMPAIR SUITABILITY FOR CLASS I, DIVISION 2.

CSA / ATEX approved devices are equipped with either a locking six pin industrial connector (IC), locking D-sub 15 pin connector (DB15) or locking D-sub 9 pin connector (DB9). Please see pages 58 - 70 for the correct power and signal connections for each type of connector.

See the following page for special conditions regarding the use of these units!

USE of instruments (L, LC, LCR, M, MW, MS, MC, MCW, MCS, MCR, MCRW, MCRS, P, PS, PC, PCS, PCR and PCRS product families only) in Class 1 Division 2 applications.



CSA certifies the use of this product for general use as well as use in hazardous locations as defined by Class 1 Division 2 Group A, B, C and D T4.

CSA certification is indicated by the product label as shown below and not by the statements in this, or any accompanying documentation.

Special Conditions:

To comply with CSA certification the following information is included in the product literature:

- When equipment is properly labeled, it is suitable in Class I, Division 2, Group A, B, C and D, T4
 - Tamb. -40°C to +50°C
- Electrical Rating 24Vdc, 0.800A max
- Instruments shall be powered by a CSA certified, UL listed, Class II external power supply suitable for the application
- Instruments shall be housed in an enclosure with a minimum IP54 rating or location providing equivalent protection
- Instrument's final approval shall be provided by the local authority having jurisdiction

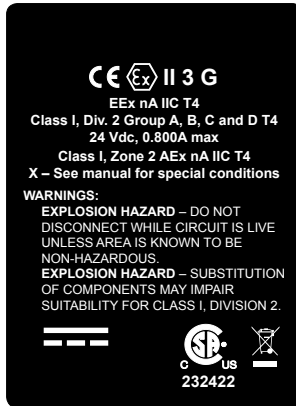

USE of instruments (L, LC, LCR, M, MS, MC, MCS, MCR, MCRS, P, PS, PC, PCS, PCR and PCRS product families only) in applications requiring ATEX Certification.



Properly labeled instruments comply to the following ATEX standard:



II 3 G EEx nA IIC T4 (-40°C ≤ Ta ≤ +50°C)

The examination certificate was issued by the CSA in accordance with accepted practices and procedures. This confirms compliance with the European ATEX Directive or Group II Category 3G equipment.

ATEX certification is indicated by the product label as shown above and not by the statements in this, or any accompanying documentation.

Special Conditions:

- Properly labeled equipment is only certified for use in ambient temperatures in the range of -40°C to +50°C only
- Electrical Rating 24Vdc, 0.800A max
- Instruments shall be powered by a CSA certified, UL listed, Class II external power supply suitable for the application
- Instruments shall be housed in an enclosure with a minimum IP54 rating or location providing equivalent protection
- Instrument's final approval shall be provided by the local authority having jurisdiction

Serial Number: _____

Model Number: _____